

~~FOR OFFICIAL USE ONLY~~

Jacob Gurin

# Sigint Technical Primer-I

## Antennas: How they work; what the different types of antennas can do

(First of a Series)

Everyone knows what an antenna is, even if some do refer to it as an aerial. It is a device which somehow sends out radio waves, or—more importantly for us—captures them and pipes them to a receiver, where they are re-created into a reasonable facsimile of the original signal plus, unfortunately, some noise. One cannot hear, see, feel, taste, or in any other way sense the presence of these waves without the assistance of some sort of antenna system, which includes, in addition to the antenna, the receiver and the connecting wires.

All that seems simple enough, but the subject is still troublesome to many of us because of the variety of antennas used and the profusion of devices and concepts associated with them. Why are there so many kinds of antennas? What is a rhombic?

In our business we are concerned with radio waves and not with other members of the same family—light waves, X-rays, cosmic rays, etc.—which differ from radio waves only in frequency. But even within the boundaries of the radiowave group, adjustments must be made to accommodate differences in frequency.

Spend a moment thinking through the relationship of frequency, wavelength, and the speed at which radio waves travel, which is the same as the speed of light. When the wave is a long one, the number of waves going past a point during a given period (frequency) will be smaller than when the wave is short. It is as though one were counting cars of varying length in a passing train. The long cars would be counted slowly; the short ones cause the count to be speeded up, even though the entire train is moving at a fixed speed. The length of radio waves varies enormously, and since the size of an antenna is influenced directly by the wavelengths it is designed to receive, there is quite a range in antennas as well. For very low frequencies the antenna may extend a mile or so parallel to the ground; for a microwave frequency of 5000 megahertz (a megahertz is 1 million cycles per second) it may be about one inch in length.

In general, antennas can pick up a signal in one of three ways. The signal may have traveled along the ground,

hugging the surfaces (ground wave); it may have bounced back off the ionosphere (sky wave); or it may have gone from transmitting to receiving antenna by line of sight (direct wave). As a general guide it may be said that in the lower frequencies most of the signals come off the ground; in the middle frequencies we make good use of sky bounce; in the higher frequencies we must rely principally on direct reception, since the signal does not bounce well but is absorbed by the ground or cuts right through the ionosphere to be lost in space.

### *Nature of Antennas*

An antenna may be used either to launch or to receive radio waves, and may even do both simultaneously at different frequencies. In practice, the design of a receiving antenna often differs considerably from that of the transmitting type. In transmission, the object is usually to put most of the transmitter's output where it is wanted. In reception, on the other hand, the object is to provide a high signal-to-noise ratio at the receiver. In addition to the random noise of the atmosphere or local noise (as from a defective household appliance), any unwanted signal that gets into a communications channel is called noise. Since modern receivers are very sensitive, the antenna's ability to discriminate against unwanted signals is as important as its ability to deliver energy to the receiver.

*Directivity.* Just as it is necessary for us to turn our heads to get a better view of an event occurring over to one side, even though we do have some side vision, so it is often necessary to turn the antenna to get better reception. The property of an antenna that causes it to receive signals more effectively from one direction than another is called *directivity*. Although for a directional antenna there will be areas of minimum reception from which virtually nothing is received, in other areas reception quality will vary up to maximum sensitivity to the incoming signal.

The remedy for unwanted signals is careful control of the antenna's directional pattern. The antenna should

~~FOR OFFICIAL USE ONLY~~ 17

~~FOR OFFICIAL USE ONLY~~

be sensitive in the direction of the desired transmitter but, more important, it should have as little sensitivity as possible in the direction of the noise source.

*Gain.* The term *gain* means "how much better than the standard." When the gain is increased, the signal comes in more strongly. The gain of an antenna depends mainly on its design. Directional characteristics in a receiving antenna increase the energy pickup or gain in the favored direction and reduce the reception of unwanted noise or signals from other directions.

*Antenna Length.* There is a direct relationship between the length of an antenna and its performance. Best results are achieved when the length of the incoming radio wave and that of the antenna are close mathematical relatives. For example, one of the most commonly used antenna lengths is one-half that of the wavelength to be received. It would also be effective if one quarter as long, one eighth, equal in length, etc., although the specific performance would change.

While the half-wave antenna is most effective for signals arriving in a direction perpendicular to its length, longer wires radiate and receive best at oblique angles, a characteristic employed in some important antenna types, such as the rhombic.

*Frequency Ranges.* Antennas usually are most effective within a limited range of frequencies, depending on their size and configuration. It is possible, however, to construct antennas that have desirable operating characteristics over a wide range of frequencies; these are called *broadband*, or *wideband*.

*Arrays.* An array is a combination of several or many individual antennas. Elements may be combined so as to obtain desired directional effects. The layout of the array and the distances between antenna elements are most important in obtaining the desired pattern. The array will permit reception from desired directions with improved signal-to-noise ratios.

*Antenna Types*

There are almost as many types of antennas as there are frequency ranges to cover and purposes to which radio waves may be put. Different kinds of antennas may be used for: microwave repeaters, point-to-point services, radio telescopes, radar systems, space communications and telemetry, mobile services and military systems. There seems to be no "best" antenna, only that which is best suited to the purpose and the purse. Likewise, it is not easy to present a neat classification system that will account for all types, but perhaps it would be useful to think of antennas as dividing into three broad classes: *linear conductors*, *wave guides*, and *optical types*, of which the first group is by far the most numerous, and the last two used almost exclusively for uhf and above.

The following does not even pretend to be an exhaustive listing of the kinds of antennas used for signal reception, even of those used in Sigint, and only the most superficial description is furnished for each type illustrated. Selection was made to illustrate some of the similarities and differences among types in current use, and to give some idea of the special purposes to which they may be put.

*Linear Conductor Antennas*

*Horizontal Dipole.* One of the most elementary forms of linear conductor antennas is the dipole. (The word means an object with oppositely charged poles.) Below are typical antennas of this type, one in its simple form and the other in its more frequently encountered and more effective folded form.

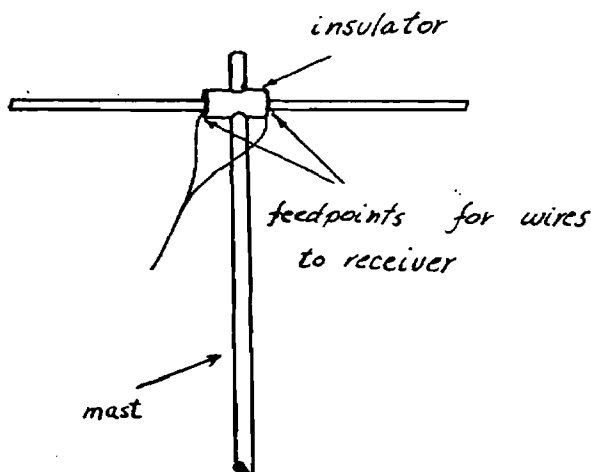
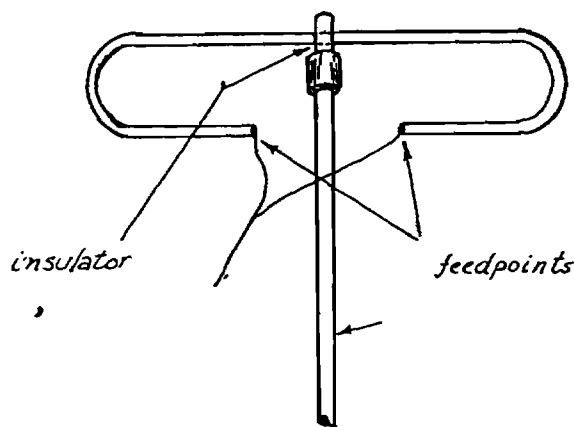

Dipole is the popular standard among antennas, as evidenced by its use in computing gain. The gain specification of most antennas is a measure of the power induced by an incoming signal as compared with that induced in a dipole cut to half the wavelength of the signal.

~~FOR OFFICIAL USE ONLY~~

*Vertical Monopole.* While the dipole is normally half the length of the wave to be intercepted, one of the most frequently used vertical antennas, the monopole, is usually one fourth the wavelength. This is possible because the ground acts as the lower half of the antenna, making the vertical monopole, in effect, a half-wave antenna of which half is below ground.

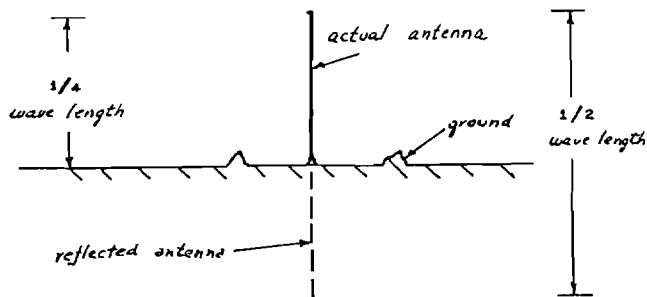

Grounded Quarter-wave Vertical Antenna

The radiation pattern of the vertical antenna allows reception from all directions, making it particularly suitable for mobile communications. This antenna is the type that is mounted on automobiles and is also known as the whip antenna.

*Loop.* The loop antenna, which may be circular, diamond-shaped, or square, is most useful in direction-finding. By rotating the loop on its vertical axis and reading the strength of the incoming signal, the bearing of the signal can be determined.

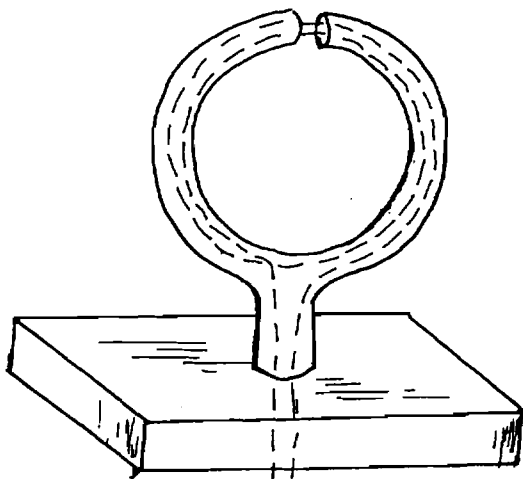

Direction-finding Loop

*Conical.* The conical antenna has certain structural and electrical advantages over other linear forms and is most useful in the reception of vhf and uhf, where the antenna must cover a wide range of frequencies. A number of variations of the conical antenna are in use, but the essential feature is tapered construction, in the shape of a cone, or, as in the bow-tie antenna, a triangle.

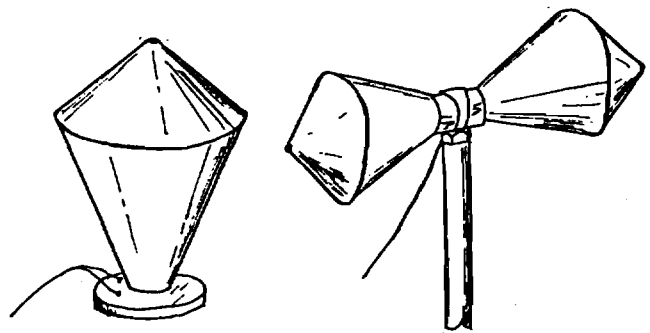

*Cage Antenna.* Similar in many ways to the conical antenna, the cage antenna is a broadband dipole antenna in which each pole consists of a "cage" of wires whose shape approximates that of a cone or a cylinder.

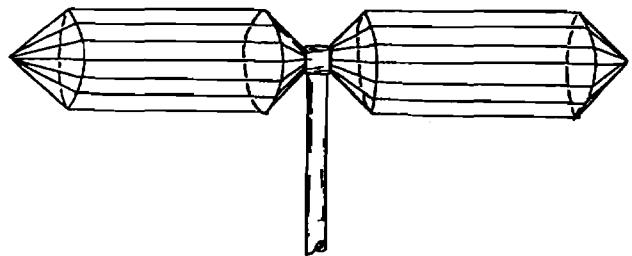

Cage Antenna

*Rhombic.* The rhombic antenna may be considered the workhorse of Sigint. It is simple to construct and maintain and is useful over a wide frequency range, but it tends to eat up a lot of real estate. The rhombic antenna consists of four long wires lying along the sides of a rhombus (a parallelogram with all sides of the same length). Each leg should be one or more times as long as the wavelength of the operating frequency, and it is this characteristic which is the source both of advantage and of difficulty. The leg length gives the rhombic its great gain and sharp directional characteristics, but it may run to several hundred feet on each side of the rhombus when the antenna is directed against targets in the hf range. By inclining the antenna with respect to the horizontal a wider frequency and distance range is achieved.

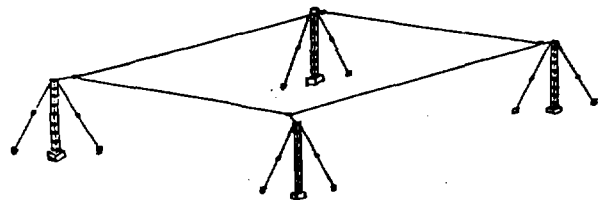

A Typical Rhombic Antenna

*Helical.* In spite of its excellent gain characteristics, the helical antenna is infrequently used in the vhf and lower frequency bands because of its large size require-

~~FOR OFFICIAL USE ONLY~~ 19

~~FOR OFFICIAL USE ONLY~~

ments at these wavelengths. However, at higher frequencies (uhf and above) the shorter wavelengths make this type of antenna very practical, and its high gain makes it desirable.

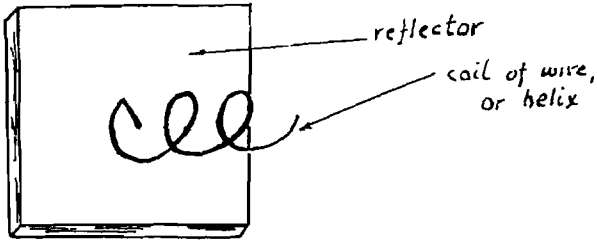

Helical Antenna

*Adcock.* It was long assumed that for direction-finding it was necessary to rotate the antenna to determine where the signal was coming from, and that is how the loop antenna is used. With the Adcock antenna, however, it is possible to rotate a goniometer (an electromechanical device that samples a number of antenna elements around an axis) to determine the direction from which a signal is coming. Thus, the antenna remains stationary, a definite advantage in mechanical design for DF systems.

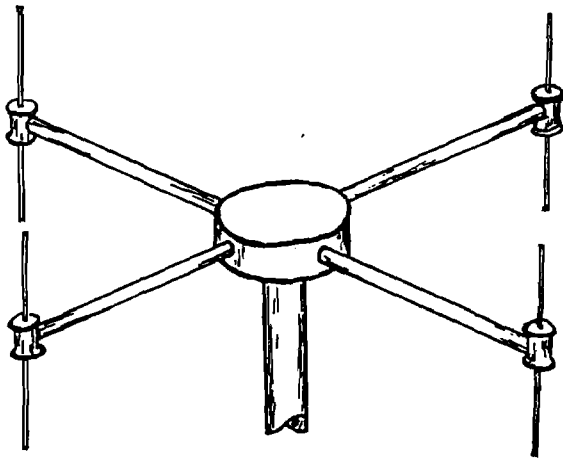

Adcock Antenna

*Stub Antenna.* Characteristically short in relation to its diameter, the stub antenna consists of a kind of finger protruding from a ground plane or reflecting surface which is very much a part of the antenna. There are many modifications of this basic pattern, which is often found on aircraft, where the skin of the aircraft is used as the ground plane. One of the modifications is the sleeve stub antenna, pictured below.

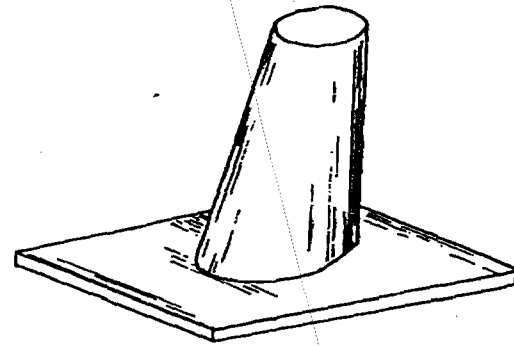

Stub Antenna

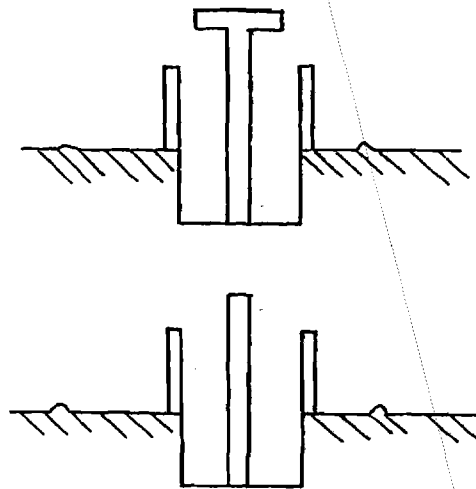

Types of Sleeve Stub Antennas

*Log Periodic Antennas.* Recently developed, the logarithmically periodic antenna helps fill the requirement for an antenna that will operate effectively over an extremely wide frequency range. The LPA is so structured that it is unidirectional (but with broad beam-width—approximately 60 degrees), has above average gain, and easily achieves bandwidths of 10 to 1, e.g., 30-300 MHz, and even 20 to 1. It can be mounted on a rotating mechanism and is particularly useful where antenna space is limited.

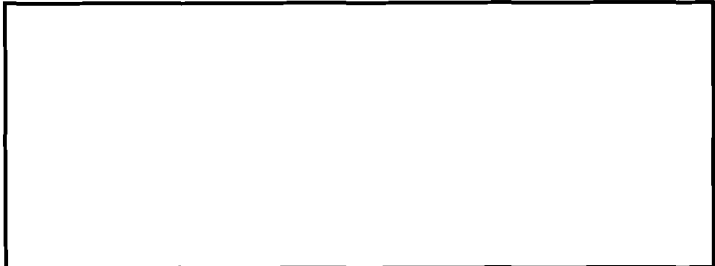

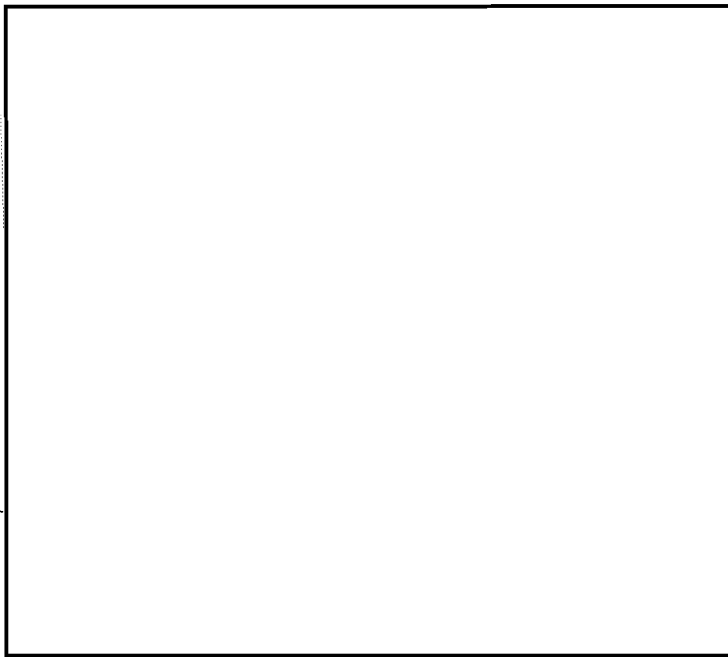
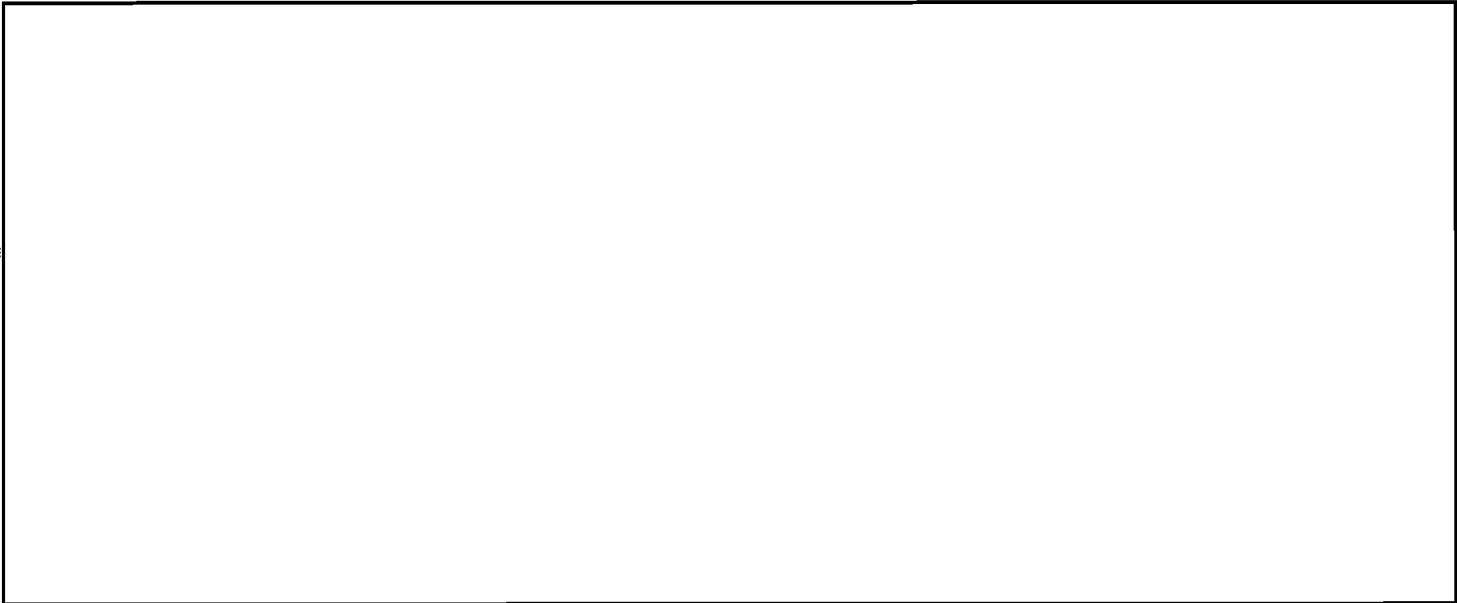

open end, through which radio waves are received and guided.

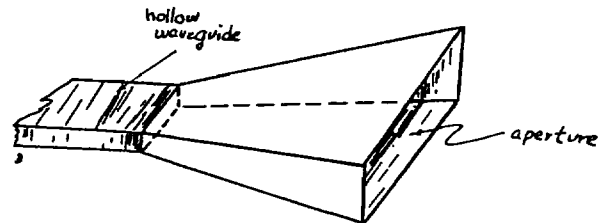

Horn Antenna

*Slots.* A complete metallic enclosure prevents the escape of energy; a break in the wall permits radiation. This is the basis of the slot antenna. Typically, the length of the slot is half the wavelength of the signal to be intercepted.

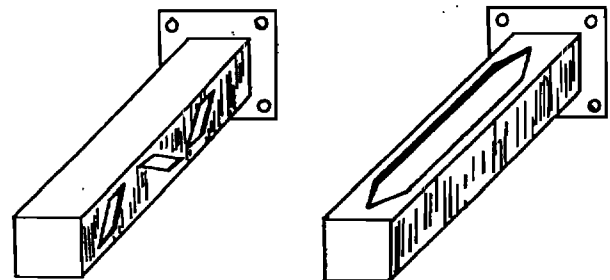

Two Examples of Slot Antennas

### Waveguide Antennas

A group of antennas important to the microwave range has developed out of waveguide technology. A waveguide is basically a transmission line consisting either of a hollow tube *within* which electromagnetic waves are propagated, or of a nonconducting material (dielectric) *along* which the waves travel. This contrasts with the usual transmission line, which employs a conductor *through* which the induced current passes.

*Horns.* A large horn antenna resembles a megaphone or ear-trumpet in its ability to concentrate waves. It is a tubular or rectangular microwave antenna, wider at the

### Optical-Type Antennas

This group of antennas is so named because electromagnetic waves share with light waves the phenomena of

~~FOR OFFICIAL USE ONLY~~

reflection and refraction and so can employ reflectors and lenses. Gain is increased substantially by *focusing* incoming signals; interception of microwave transmissions would be virtually impossible without this focusing of the energy. Any material having high electrical conductivity reflects radio waves, which may be focused onto a half-wave dipole, a small horn, or to specially designed slots in a waveguide.

**Reflectors.** There are a number of possibilities for improving antenna performance by providing a reflector which will strengthen reception of the incoming signal. An example is combining a flat or angled reflective screen with an active dipole element. Pictured are bow-tie antennas backed up by elements which bounce the signal back to the dipole. It is significant that energy arriving from the back side of the reflecting elements will not be picked up by the dipole, making the system unidirectional.

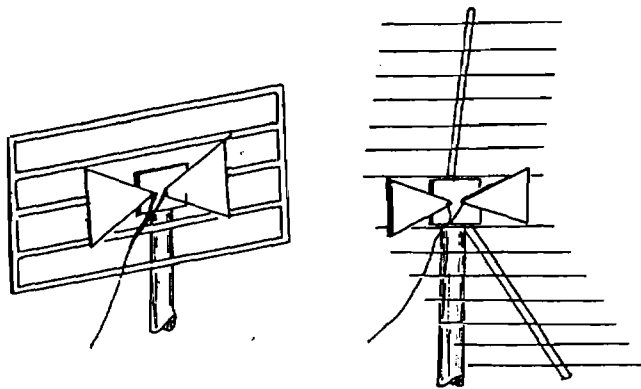

**Bow-tie Antennas with Reflectors**

The *billboard antenna* (also called *bedspring* or *mattress*) is an arrangement of dipoles backed up by a flat reflecting surface. The reflecting surface, which may be continuous or constructed of rods or mesh, serves to double the receiving pattern forward of the antenna.

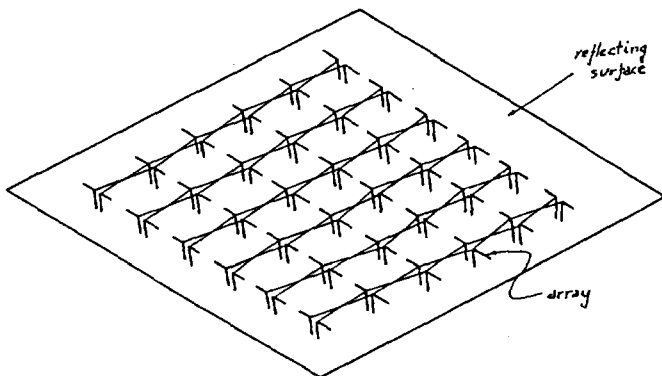

**Billboard Antenna**

**Parabolic Antennas.** It is characteristic of the paraboloid surface that it will reflect any ray or wave to the point of focus, regardless of the angle at which the reflector is hit. In the parabolic antenna this permits focusing the energy received throughout the paraboloid surface onto the single point at which is located the waveguide or other device for directing the concentrated energy to the receiver.

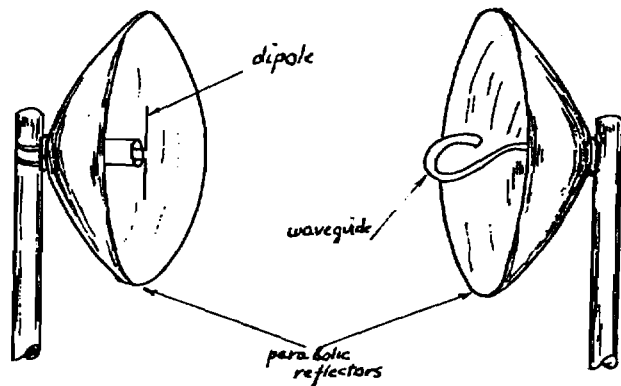

**Types of Parabolic Antennas**

**Lens Antennas.** Just as an optical lens alters the path of light by refracting it, so the lens antenna refracts electromagnetic energy. The lens may consist of metal baffle plates bent, shaped and so arranged as to correspond to a convex lens. A waveguide lens may be formed by combining short, hollow waveguides which differ in length or some other dimension.

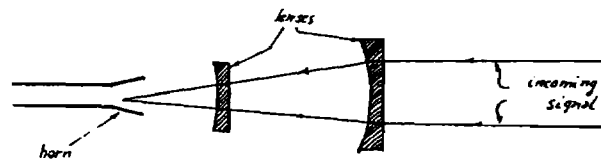

**Action of a Lens Antenna**

**Parasitic Elements**

The gain of an ordinary dipole can be increased by the addition of *parasitic elements* placed either in front of or behind the dipole, or *driven element*. Depending on their length and where they are placed with respect to the driven element, these parasitic elements are termed *directors* or *reflectors*. Reflectors, which were discussed above with optical-type antennas, are placed behind the driven element, while directors project the radiation from in front to the antenna proper. The signal energy picked up by the directors and radiators is added to that



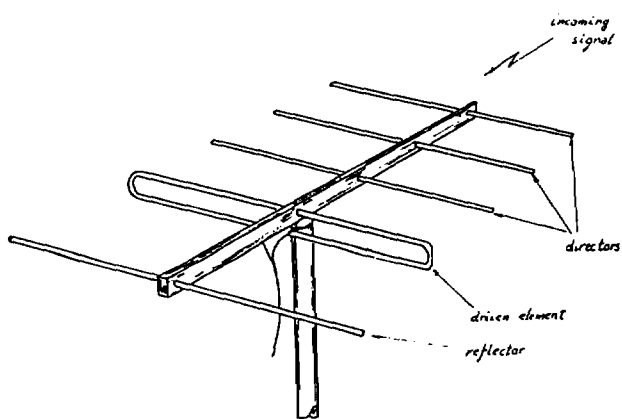

Yagi Antenna

acquired directly by the driven element, increasing the antenna's gain.

*Yagi Antenna.* Any antenna array having one active element and two or more parasitic elements (one reflector and one or more directors) is known as a Yagi antenna, named for its Japanese originator. This is the antenna most commonly used for TV reception. The Yagi is highly directive and has extremely high gain, but its frequency coverage is limited. Some compensation for this can be provided by varying the number of elements, their diameter, and the spacing between them.

Jack Gurin served as a Japanese linguist with Military Intelligence in World War II and entered Sigint with ASA in 1946. He has held a great variety of line, staff and technical positions and also managed to contribute frequently to cryptologic literature—as well as the NSA Men's Chorus, the Jazz Band and the Phoenix Society.