

Conspiracies • Behind the News • Health • UFOs • Future Science

NEXUS

NEW TIMES • Vol 5, No 4

Exposed: The Cover-up on Contaminated Vaccines

MAI: the New Economic Order

The Mysterious Origins of Man

Tamoxifen: a toxic time-bomb?

The Royal Bloodline of Jesus and the Holy Grail

JUNE - JULY 1998

AUSTRALIA	\$4.95
NZ (incl GST)	NZD \$5.95
USA	USD \$4.95
CANADA	CAN \$5.95
UK	STG £2.50
NETHERLANDS	NFL f8.95



Print Post Approved PP442036/0005

+ Atlantis in Antarctica Pt 2 • Dr Sam Chachoua Pt 2 • Reviews

NEXUS

NEW TIMES MAGAZINE

Volume 5, Number 4 JUNE - JULY 1998

PO Box 30, Mapleton Qld 4560, Australia

CONTENTS

LETTERS TO THE EDITOR.....	4	ATLANTIS IN ANTARCTICA?—Part 2.....	55
GLOBAL NEWS.....	6	<i>With Rand Flem-Ath. In concluding his lecture on Antarctica being the lost continent of Atlantis, this research librarian discusses crustal shifts, Great Flood legends and the origins of agriculture.</i>	
<i>A round-up of the news you may have missed.</i>		THE TWILIGHT ZONE.....	63
THE HIDDEN HISTORY OF JESUS—Part 3.....	13	<i>Strange tales from around/within/beyond the world. This issue, we report on the controversy over the Martian landscape anomalies, and the Vatican's interest in the implications of extraterrestrial contact.</i>	
<i>With Sir Laurence Gardner. The final part in this series considers the bloodline descendants of Jesus Christ and rise of the Grail courts against the backdrop of suppression by the Church of Rome.</i>		THE MYSTERIOUS ORIGINS OF MAN.....	67
VACCINE CONTAMINATION: Germ Warfare?.....	21	<i>By Michael Cremo. Darwinian dogma has been challenged by the discovery of artefacts in ancient rock strata and the suggestion that humans may have been on Earth many millions of years ago.</i>	
<i>With Dr Leonard Horowitz, interviewed by Dr Roger Mazlen. For decades, health authorities have known that vaccines contain foreign viral contaminants, but have done little to remove them.</i>		REVIEWS—Books.....	73
MAI GALOMANIA! THE MAI AGREEMENT—Part 2.....	27	<i>"Hidden Agendas" by John Pilger</i>	
<i>By Corporate Europe Observatory. This feature concludes with analysis of the corporate global investment agenda behind the MAI, and the citizens' campaigns that are exposing its flaws.</i>		<i>"Mad Cow USA" by Sheldon Rampton and John Stauber</i>	
INDUCED REMISSION THERAPY—Part 2.....	35	<i>"The Earth's Shifting Axis" by Mac B. Strain</i>	
<i>By Dr Sam Chachoua. Applying the "nemesis" theory that for every disease there is an antidisease organism, this maverick doctor has developed compounds that can cure AIDS and cancer.</i>		<i>"Gods of Eden" by Andrew Collins</i>	
TAMOXIFEN: A MAJOR MEDICAL MISTAKE?.....	43	<i>"Vaccination Roulette" from Australian Vaccination Network</i>	
<i>By Sherrill Sellman. The synthetic hormone-like drug Tamoxifen may be having limited success against breast cancer recurrence, but it is already proving to have life-threatening, toxic side-effects.</i>		<i>"The Second Messiah" by Christopher Knight and Robert Lomas</i>	
NEW SCIENCE NEWS.....	51	<i>"Can Bacteria Cause Cancer?" by David J. Hess</i>	
<i>Interesting news and views from the underground science network. In this issue, Martin Gottschall describes a thermal converter that has exciting potential for the unlimited recycling of heat energy.</i>		<i>"The Case for The Face" edited by S. McDaniel and M. Rix Paxson</i>	
		<i>"The Keys to the Temple" by David Furlong</i>	
		<i>"Bringing the War Home" by William Thomas</i>	
		<i>"Milk: The Deadly Poison" by Robert Cohen</i>	
		<i>"The Mystery of Easter Island" by Katherine Routledge</i>	
		<i>"The Sirius Mystery" by Robert Temple</i>	
		<i>"Kombucha Tea For Your Health..." by Alick and Mari Bartholomew</i>	
		REVIEWS—Videos.....	80
		<i>"Lethal Medicine"</i>	
		<i>"Vaccination: The Hidden Truth"</i>	
		<i>"High Strange New Mexico"</i>	
		REVIEWS—Audio.....	81
		<i>"Emer Kenny" (self-titled)</i>	
		<i>"Café Paradiso" by Steve Erquiaga</i>	
		<i>"The Music of Islam" (compilation)</i>	
		<i>"Chakradancer" by Brainscapes</i>	
		<i>"Stormbird" by Matthew Doyle and Tony Lewis</i>	
		NEXUS BOOKS, SUBS, ADS & VIDEOS.....	97

NEXUS MAGAZINE

Volume 5, Number 4

JUNE - JULY 1998

PUBLISHED BY

NEXUS Magazine Pty Ltd, ACN #003 611 434

EDITOR

Duncan M. Roads

CO-EDITOR

Catherine Simons

ASSISTANT EDITOR/SUB-EDITOR

Ruth Parnell

EDITORS' ASSISTANT

Richard Giles

OFFICE ADMINISTRATOR

Janine Carmichael

CONTRIBUTORS THIS ISSUE

Sir Laurence Gardner, Kt St Gm, KCD; Leonard G. Horowitz, DMD, MA, MPH; Dr Roger G. Mazlen; Corporate Europe Observatory; Sam Chachoua, MB, BS; Sherrill Sellman; Martin Gottschall, PhD; Rand Flem-Ath; Michael A. Cremona

LAYOUT & DESIGN

Duncan M. Roads

CARTOONS

Phil Somerville

COVER GRAPHIC

John Cook, jscook@ozemail.com.au

PRINTING

Warwick Daily News, Queensland, Australia

AUSTRALIAN DISTRIBUTION

Newsagents Direct Distribution

HEAD OFFICE - All Correspondence

PO Box 30, Mapleton, Qld 4560, Australia.

Ph: (07) 5442 9280; Fax: (07) 5442 9381

E-mail address: nexus@peg.apc.org

Web page: <http://www.peg.apc.org/~nexus/>

NEW ZEALAND OFFICE - PO Box 226, Russell,

Bay of Islands. Ph: +64 (0)9 403 8193;

Fax: +64 (0)9 403 8196;

E-mail address: nexusnz@xtra.co.nz

USA OFFICE - PO Box 177, Kempton, IL 60946-

0177. Ph: (815) 253 6464; Fax: (815) 253 6454

E-mail address: nexususa@earthlink.net

UK OFFICE - 55 Queens Rd, East Grinstead, West

Sussex, RH19 1BG. Ph: +44 (0)1342 322854;

Fax: +44 (0)1342 324574;

E-mail address: nexus@ukoffice.u-net.com

EUROPE OFFICE - PO Box 372, 8250 AJ Dronten,

The Netherlands. Ph: +31 (0)321 380558;

Fax: +31 (0)321 318892;

E-mail address: frontier@xs4all.nl

STATEMENT OF PURPOSE

NEXUS recognises that humanity is undergoing a massive transformation. With this in mind, NEXUS seeks to provide 'hard-to-get' information so as to assist people through these changes. NEXUS is not linked to any religious, philosophical or political ideology or organisation.

PERMISSION-TO-REPRODUCE POLICY

While reproduction and dissemination of the information in NEXUS is actively encouraged, anyone caught making a buck out of it, without our express permission, will be in trouble when we catch them!

Editorial

I've not long finished watching two of the videos for review this issue, and what a shock they were to my system! The video on animal experimentation and the one on vaccinations are so well-presented in terms of educational content that I have little choice but to feel extremely frustrated at the stupidity of the whole situation. I'm sure you know the feeling: you want to go out there and make everyone you know (and everyone you don't know) digest the same information so that we can change 'the system' for the better.

But, simultaneously, you realise the sheer extent of 'the system' that perpetuates the myth that animal experiments have *any* medical value to humans, or the myth that vaccines and immunisations work at all. We are up against many multibillion-dollar transnational corporations, plus the 'researchers' and 'experts' they employ, plus the government bureaucracies they 'lobby', plus the media corporations with whom they advertise, plus the often well-meaning but sometimes totally ignorant medical profession, plus the majority of the often well-meaning but sometimes ignorant general public.

I believe the only practical and effective solution is not to 'fight' the 'old' but to concentrate on building the 'new'. Building the 'new' is so much easier, more efficient and stress-free. It is health-improving, emotionally enriching and soul-satisfying.

Building the 'new' might sound like a 'new age' catch-phrase, but it is really very easy. It starts with taking responsibility for your life, particularly your health (and not just your physical health). By stepping away from the general herd of the junk-food, junk-information consumer society around you and reading about what you are putting on and into your body—this is pretty close to step number 1. The rest follows naturally.

By living a clean and aware life, you participate with millions of others who have chosen to do likewise. Unfortunately for most of us, it usually takes some form of 'crisis' before we are sufficiently motivated to change. Thus, I like to believe that there is a steadily growing number of people 'waking up' to the many deceptions both foisted upon and perpetuated by modern society.

Now that I've got that off my chest, let's get into this edition of the magazine.

You will notice that at long last we have part 2 of Dr Sam Chachoua's article on Induced Remission Therapy. What we've actually done is run a transcript of Sam's presentation at the 2nd World Congress on Cancer, held in Sydney, with an update on what has happened since. You'll notice that he's having extraordinary success with the treatment of AIDS.

Speaking of success with treating AIDS, Basil Wainwright, inventor of the polyatomic apheresis unit that ozonates the blood, is working in Kenya and has documentation on 52 patients who are now HIV-negative (see Global News).

And while on the subject of oxygen therapies, spare a few thoughts for Ed McCabe who lies rotting in Syracuse County Jail, New York—a political prisoner persecuted by the authorities for spreading information on oxygen therapies and other similarly 'subversive' subjects. Please phone or e-mail your support to his volunteer helpers in the USA asap (see Global News this issue).

Finally, I would like to extend a big thank-you to all readers who send in newspaper and magazine clippings of interest. This is greatly appreciated! One thing, though: if you do take the time to send us something, please make sure you put the newspaper/magazine name and date on the clipping so we can tell others!

Happy reading!

Duncan

WARRANTY AND INDEMNITY

Advertisers upon and by lodging material with the Publisher for publication or authorising or approving of the publication of any material INDEMNIFY the Publisher and its servants and agents against all liability claims or proceedings whatsoever arising from the publication and without limiting the generality of the foregoing to indemnify each of them in relation to defamation, slander of title, breach of copyright, infringement of trademarks or names of publication titles, unfair competition or trade practices, royalties or violation of rights or privacy AND WARRANT that the material complies with all relevant laws and regulations and that its publication will not give rise to any rights against or liabilities in the Publisher, its servants or agents and in particular that nothing therein is capable of being misleading or deceptive or otherwise in breach of the Part V of the Trade Practices Act 1974. All expressions of opinion are published on the basis that they are not to be regarded as expressing the opinion of the Publisher or its servants or agents. Editorial advice is not specific and readers are advised to seek professional help for individual problems.

© NEXUS New Times 1998

Letters to the Editor ...

The Medium is the Messenger

Dear Sir: My grandmother was a materialisation medium named Helen Duncan. She was tried in 1944 at London's Old Bailey under an archaic law, "Witchcraft Act, 1735".

During World War II she was sensitive to vibrations coming from the water. She knew about the sinking of two British warships before the government did.

Sir Dudley Pound, then First Sea Lord and Chief, Naval Staff, is reported to have said: "Suppose there is something to what this woman and others are? Our whole intelligence operation could be defeated. Somehow this woman must be silenced."

It is reported that Admiral Andrew Browne Cunningham, in command of British Forces in the Mediterranean, ordered: "Helen Duncan must go to gaol. If you can't find one, make one up."

Winston Churchill sent a note to the Home Secretary, stating: "I want to know the cost to a nation at war, of a trial in which the recorder has been kept busy with all this tomfoolery, to the detriment of necessary work in the courts." Because of my grandmother's trial, Winston Churchill changed the law in 1951 whereas a medium could never be tried under that law again.

It is now 54 years later and I am searching for evidence that will clear my grandmother's name. I am appealing to you and your readers to become involved and to help me uncover the truth so that I can exonerate her. I want to correct a terrible injustice done to a great medium who happens to be my grandmother.

Sincerely, Margaret Parrington, 424 E. 63rd St, Long Beach, CA 90805, USA, telephone (562) 423 5398; e-mail, maggiep@gte.net; website, www2.arkansas.net/~spirit/update.htm

Vivisection Research Fraud

Dear Editor: I would like to applaud your magazine and its often fascinating and informative articles. I do have a beef, however, with some of the medical conspiracies. Though the drugs/CIA sort of stuff is backed up with much documentary evidence, I feel the medical stuff is more subjective.

My main concern is the methods of your 'maverick' researchers. They follow the same discredited root of vivisection (animal research is one of the biggest conspiracies/frauds of all time). Any information gleaned from such a damaging and inaccurate research method is no loss to the world.

I am not going to bombard you with the trad animal rights points of how the animal and human are completely different, and neither will I list the thousand thalidomides we have suffered through animal-directed research.

I will just say that these are no maverick geniuses—they are old-school, pro-status-quo researchers. Forget them.

Love, J.R., ab0u7057@liverpool.ac.uk

Silicone Implants Scandal

Dear NEXUS: I am the acting co-ordinator of the Breast Implant Resource Service which counsels and assists women who have been harmed by silicone breast implants through the lies and cover-ups of chemical corporations and the medical fraternity.

The dangers of silicone used in the human body have been known since before the Second World War, but the damning evidence has always been buried or destroyed. Up to the present time, it is still claimed to be safe.

There are millions of women who are ill from the effects of silicone poisoning, and those, like myself, who have been mutilated through operations to remove loose silicone from the body. Silicone has been found in the frontal lobes of the brains of women whose implants ruptured, as well as in the liver, lymph nodes and intestinal tract.

Through our worldwide network of silicone survivors, we have gathered a mountain of testimony from women who are suffering; from scientists and researchers who have worked for the chemical companies and have decided to become whistle-blowers because of the cover-ups; and from doctors who can no longer remain silent about the disaster which silicone causes.

Between 1 January 1985 and 16 March 1995, the American Food and Drug Administration received 91,322 adverse-reaction reports associated with silicone breast

implants and 19,296 reports involving the saline implants (these have an outer covering of silicone). At present, 300,000 American men who received penile silicone implants are suing the manufacturer for injury.

As you may be aware, the major silicone breast implant manufacturer Dow Corning has been embroiled in a global class-action with women who claim that their implants caused illness, injury and mutilation and affected their breast-fed children. Dow Corning has always denied liability on any count and is using any obstruction it can find to avoid paying compensation to the women. Even its own internal memos about the findings of studies carried out on laboratory animals—evidence which could bury them for all time—are being ignored by the courts hearing the appeals and the United States Government because of lobbying done on behalf of Dow Corning.

We women are determined that the truth will be known, and that silicone breast implants will be taken off the market forever. We are doing everything possible to bring this issue to the notice of the public and the Australian Government—which is, conveniently, burying its head in the sand over this issue, no doubt due to heavy lobbying by the AMA.

The Australian Department of Health knows the extent of the damage through Medicare payments to hospitals where women have had revision surgery, time after time, to attempt to correct the disaster.

If you are ever interested in doing a story to expose the gigantic mess of silicone, millions of women worldwide would thank you, and readers would be appalled at yet another gigantic cover-up.

Sincerely, Chris Tiley, ce@key.net.au

On the Trail of the Holy Grail

Dear Duncan: First of all, I have to say how much I enjoy NEXUS. I have been reading it for over two years. When I read each issue, I always think that no other issue could be better than that one. However, you and your team do it every time. Thank God there are people like you out there who are willing to take a risk and expose

the truth. Be proud!

Moving on, after reading the article on the Holy Grail in February-March issue [5/02], I showed it to a friend of mine. The following day she produced the book, which she had run out and purchased. Since then I have set up a study group, and the five members intend to meet once a month over dinner to discuss the book and to visit some of the sites mentioned in the book.

If I didn't read NEXUS I would have missed this very important book. I have seen books on the Holy Grail on the bookshelf and sadly assumed that they were all about King Arthur. Thanks again, Duncan. (And I thought I was well-read!)

I would be grateful if you could let me know of any other books that could help us on our trail. We are interested in all aspects of the Grail. Thanks, Duncan.

Yours sincerely, Linda Williams, London, UK

Shining Light on the Slime

Mr Roads: Thank you ever so much for publishing NEXUS. Your magazine gives me a tool (a touchstone, rather) to help educate people as to what's *really* happening in today's world.

My wife has studied alternative medicine, healing, etc. for many years, but—like a recent letter you published from some whiny Berkeley, CA liberal [Letters, 4/03]—had convinced herself that she was powerless to do anything about CIA, mind control, drug wars, banksters, politicians, etc. Now she sees that lifting a rock and shining a light on the slimy creatures that live there takes away their power and transfers it to us.

Please continue to publish on government corruption, international banking, drugs, weapons, lawyers, the Skull & Bones, Bilderberg, Trilats, mind control, social engineering, Col. Bo Gritz, Waco cover-up, etc., etc.

Resister, Arizona desert, USA

No TLC from TNCs

Dear Duncan: Received the latest edition of NEXUS [5/03] and I thought I would write a brief note in appreciation of the first part of "MAlgalomania!"

I recently started to read an

... more Letters to the Editor

NB: Please keep letters to approx. 100-150 words in length. Ed.

excellent (prophetic?) book, titled *Global Reach: The Power of Multinational Corporations*, by R.J. Barnet and R.E. Muller. My copy was printed in 1975 by Jonathan Cape. Let me quote a few extracts from the just over 500-page book (without, I hope, breaking copyright):

Page 21: "Corporations that buy, sell and produce abroad do have the power to affect the lives of people and nations in a manner that necessarily challenges the prerogatives and responsibilities of political authority. How can a national government make an economic plan with any confidence if a board of directors meeting 5,000 miles away can, by altering its pattern of purchasing and production, affect in a major way the country's economic life?"

Page 23: "The disclosures of ITT's efforts to bring down the Allende government have confirmed widespread fears that the global corporations have too much power, but that they abuse that power. There is increasing concern around the world that the global corporations are in a position to dominate governments, dislocate national economies, and upset world currency flows. Corporate managers have such power to shift capital, develop (or suppress) technology, and mold public moods and appetites that even the most powerful governments worry about their ability to control them..."

Page 29: "It is beyond dispute that persons and institutions operating in these markets [currencies] have the resources with which to generate international monetary crises of the sort that have plagued major central banks in recent years...[US]\$268 billion, all managed by private persons and traded in private markets virtually uncontrolled by official institutions anywhere...more than twice the total of all international reserves held by all central banks and international monetary institutions in the world..."

When you and I and a certain George Soros are dead a long time, and researchers look at the causes of what was then known as "the Asian currency crisis", I wonder how much blame/credit will be given to him and a few other elite currency controllers acting as a battering ram to bring on the crises—followed by nations being

'rescued' by the World Bank and IMF to pave the way for US transnationals to buy banks and industries cheaply, thereby increasing their hegemony over the world.

Geoffrey Halton, Winston Hills NSW, Australia

Fighting for Health Freedoms

Dear Duncan: The full-page advert on page 84 of the last issue [5/03, Aust. edition], placed by the Australian Healthcare Consumers Association, says it all. If we don't get off our apathetic rear-ends and do something now to help the AHCA (like joining—they are fighting for us), then we will get what we deserve: a medical/pharmaceutical monopoly.

It appears that the powers-that-be don't just want 95% of profits arising from the sales of drugs and other pharmaceutical products; they now want all the profits for the sales of all types of natural medications. And as the record of the natural remedies industries is infinitely better than the pharmaceutical industry as far as adverse reactions and fatalities are concerned, what is the real reason for these proposed unfair, ridiculous, draconian regulations? Obviously they are not to protect the consumer, so we can only assume they are to protect the interests of the pharmaceutical industry—an industry responsible for thousands of fatalities every year, to say nothing about further thousands who are made seriously ill.

The AHCA is fighting for you, the health-conscious person who simply wants a fair deal and not a monopoly. Let's do it.

Peter O'Dwyer, Salisbury, South Australia

Non-Gulf War Syndrome

Dear Duncan: We get *El Español en Australia* newspaper, printed weekly in Sydney. My husband has a full page from it where they say that there were many soldiers who were vaccinated for anthrax but didn't get sent to the Gulf War. However, these soldiers also developed the syndrome.

We wondered whether you were aware of this and, if not, would you like the info? It comes from SE/Berne (Switzerland?) and I guess SE would be the news

source. If you can't trace it, my husband could (perhaps) be persuaded to translate it for you.

Regards, Jo Wall de Gallo, Queensland, Australia

Pyramid's Secret Chambers

Dear Duncan: I've nearly finished reading Richard Hoagland's interesting book, *The Monuments of Mars* (1996 edition).

On page 284 there is a lengthy footnote, stating *inter alia*: "In May 1986 a French archaeological team...made a startling discovery within the Great Pyramid: three previously unknown 6 x 9 foot chambers behind at least nine feet of limestone blocks..." The footnote goes on to say that the French have secured permission to drill four 1½-inch holes through the limestone and insert a high-tech camera into the chambers.

Do you, Duncan, or any of your readers know whether the foregoing ever came to pass? I attach a photocopy of the relevant page from *The Monuments of Mars*.

Yours faithfully, Alan Stewart, Port Macquarie, NSW, Australia
(Dear Alan: *There is an item in Global News this issue which may be connected, and the new edition of Richard Noone's 5/5/2000 is a must-read! Ed.*)

Mysterious Australia Research

Dear Duncan: Since the publication of my highly successful first book, *Mysterious Australia*, I have received many phone calls from readers. However, shortly after the book was published, my family and I had to leave the house we had been renting at Tamworth. It was this address which had been published in my book.

We did have the mail redirected for some time. However, letters have continued to flow in to the old address, but not all have reached us because the new tenant no longer redirects them.

So, in future, readers wishing to contact me can do so by writing to PO Box W285, West Tamworth NSW 2340, or phoning me on (02) 6762 2357. [International callers need to add the prefix "61" for Australia and drop the "0"]

NEXUS readers will be pleased to know I am currently writing my next book.

Yours sincerely, Rex Gilroy, West Tamworth, NSW, Australia

Scotland's Second Coming?

Dear Editor: I read the first part of "The Hidden History of Jesus" [5/02] and enjoyed it. It touched on several topics I have seen competently explained by other writers.

I waited eagerly for the second instalment because, after a few enquiries, I could not find a bookstore with a copy of Sir Laurence Gardner's book.

After reading the second part in April-May issue [5/03], I was even more keen to obtain a copy of the book (which I did, by chance, a few days ago). It is a great read, and recommended to anyone who is interested in European history and the forces behind the scenes shaping and moulding the history of the modern world, as it is taught.

It also had my imagination working overtime, for as recently as a few weeks ago the Scottish Parliament re-established its independence from the ties to the English Parliament. (Does this mean Her Majesty is no longer the Queen of Scotland?)

In the final few pages of his book, Gardner mentions that the current Stewart heir apparent presented in Belgium in 1990 an updated Charter of the Royal House of Stewart (Jesus' blood descendants), which has been publicly legitimated by many of the Royal Houses of Europe. This, along with the peace initiative recently brokered with the Irish by Tony Blair (NWO), looks more and more intriguing.

Is Prince Michael James Alexander Stewart (the heir apparent) a Mason, or part of the New World Order process? Will he this year, or next, become the King of Scotland? Will this be promoted as the Second Coming of Christ (i.e., the restoration of the House of Stewart, bloodline of Christ)? Will this lead on to the re-establishment of the House of Stewart as the Kings of Jerusalem? Will this lead to religious pogroms and crusades against the Catholics and Protestants, with the help of the Muslims?

I am sure that in the next 12 months the NWO is going to make itself more and more visible, as the dominoes continue to fall into place.

John Jay Fischer, fischer.ink@onaustralia.com.au

NO ESCAPE FOR MOBILE PHONE USERS

On 28 December 1997, the *Sonntags Zeitung* in Zürich revealed that Swiss police have been tracking vast numbers of mobile-telephone users with the help of the state telephone company, Swisscom, which confirmed its computers were recording billions of movements over more than the last six months.

With 3,000 base stations across the country, it can track the location of cellphones to within a few hundred metres whenever they are switched on and not just when users are having conversations.

In the USA, as of January 1998, the Federal Communications Commission (FCC) holds cellular network operators responsible for providing the location of cellular base stations used for emergency calls by cellphone users. In 2001, US cellphone operators will have to provide the location within 125 metres.

(Source: *Intelligence*, no. 74, 26 January 1998)

DUTCH NET PROVIDERS MUST MAKE NETWORKS TAPPABLE

On 2 April 1998, the Second Chamber of the Dutch Parliament approved a new Telecommunications Act that includes a chapter intended to force cable operators and Internet service providers to make their networks tappable by the police and intelligence services.



The first article states: "Providers of public telecommunications networks and public telecommunications services shall not make their telecommunications networks and telecommunications services available to users unless they can be wiretapped." A further paragraph adds that the operator of the network or the service must supply the necessary equipment and bear its full cost.

(Source: *The New York Times*, 14 April 1998; *news.com* story)

EU AND FBI PLAN GLOBAL SURVEILLANCE SYSTEM

The European Union, in cooperation with the FBI, is launching a system of global surveillance of communications to

combat "serious crime" and protect "national security", but to do this they are creating a system which can monitor everyone and everything. It seems extraordinary, given the concern over the Police Bill in the UK and the "Clipper chip" in the USA, that there has been no debate over the creation of a global telephone-tapping system initiated by the EU and the US and supported by Australia, Canada, Hong Kong and Norway.

The Council of the EU and the FBI in Washington, DC, have been cooperating for the past five years on a plan to introduce a global telecommunications tapping system. The system takes advantage of the liberalisation of telecommunications (where private companies are

taking over from national telephone systems) as well as the trend towards replacement of land/sea-based telephone lines and microwave tower links with new-generation satellite communications technology.

(Source: *Staterwatch*, London, UK; e-mail, staterwatch-off@geo2.poptel.org.uk)

REMOTE SMART-CARD READER ALERT

On Track Innovations Ltd (OTI), a leading Israeli company developing contactless smart-card technology and applications, has announced the addition of the SCI5000 Eyecon multi-reader to its family of smart-card readers.

According to an OTI press release, it is part of a new SCI5000 family of OEM boards for chip-card readers. These boards are miniature card-readers, about the size of a credit card and only 15 mm thick. The antenna used for contactless communication can be either a local unit in the reader or a remote passive antenna, connected to the SCI5000 via coaxial cable up to 33 metres (110 feet) in length.

The Eyecon features bi-directional data transmission to/from the IC card at 106 Kbps and higher, and a patented passive 'electronics-free' antenna for added security and easy physical integration. The passive antenna can be mounted in a remote location up to 33 metres from the SCI reader/writer. It allows simultaneous transmission of both power and bi-directional read/write messages to contactless IC cards.

(Source: *OTI press release*, 25 June 1997)

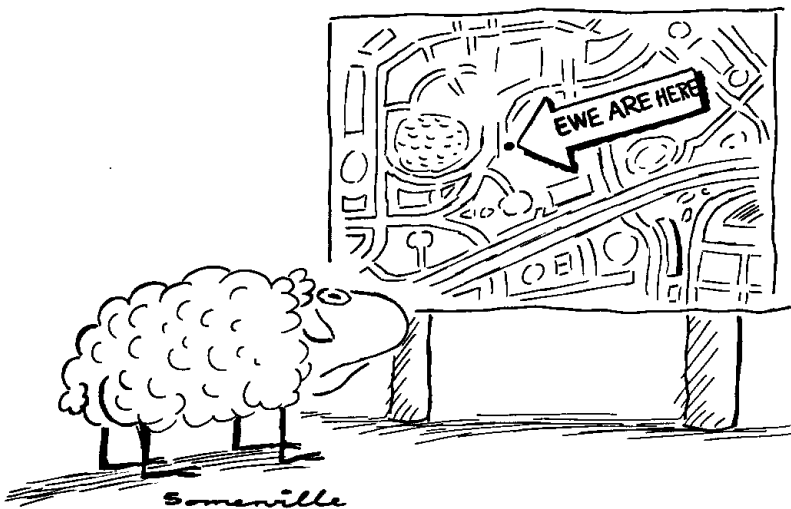

LLOYD'S INSURERS PREPARE FOR 'THE BIG ONE'

Lloyd's, the international insurance giant, has set up a 'millennium' study group to examine the possible effects of the planetary alignment due to occur in May 2000. The conjunction of planets, which includes Mercury, Venus, Mars, Jupiter and Saturn plus the Sun and the Moon, is predicted to generate a collective gravitational 'pull' that could instigate earthquakes, tidal waves and volcanic eruptions.

The study group, formed by D. P. Mann, one of the biggest non-maritime syndicates at Lloyd's, has asked Dr Julian Salt, an insurance expert specialising in risks posed by natural perils, to examine the possible threat for a seminar for Lloyd's directors and underwriters.

(Sources: The Sunday Times, UK, 3 May 1998; The Australian, 4 May 1998)

SECRET EXCAVATIONS AT THE GREAT PYRAMID

British researchers claim the "discovery of the century" has been made at the Great Pyramid of Giza. The team believes the Egyptian authorities are carrying out secret excavations in a tunnel which may lead to three previously unknown chambers. They secretly videotaped inside the Pyramid the day before the authorities closed it for an eight-month "renovation project", and consider the Egyptians' action is simply a cover for the excavation.

"It is the discovery of the century," said Simon Cox, one of the researchers. "This find could solve the greatest mystery of all time. The scale of it is just amazing. We have been told by three independent sources that the tunnel leads to three new chambers. Who knows what is inside them. It could be treasure troves full of gold coins or just empty rooms."

Cox, who studied Egyptology at the University College, London, found evidence of the tunnel on 1 April during one of his regular monthly visits to the pyramids. With researchers Clive Prince and Lynn Picknett, he came across a metal grille in a wall inside the antechamber leading to the King's Chamber.

"I'd never seen it before," explained Mr Cox. "The grille was rusty, but the mortar holding it to the wall was new."

Shining their torches inside the 3.6 ft by 2.5 ft gap, they saw a tunnel high enough to stand up in, with two stairs leading

upwards. Electric cables ran along the ceiling, indicating that lighting or machinery was being used. Though filming is forbidden, the team used a hidden video camera to record their find.

Sources have since told them that workers found the tunnel using sonar equipment, and then discovered the three new chambers.

"It is no coincidence the Pyramid has closed down now," said Mr Cox. "It gives them an opportunity to explore these new areas without anyone knowing."

Work on the Great Pyramid is kept low-profile to avoid experts descending from around the world and treasure hunters trying to steal artefacts.

(Source: Daily Mail, UK, 18 April 1998)

UNDERWATER VOLCANOES THE REAL CAUSE OF EL NIÑO?

More and more scientists are examining the possibility that the changing weather patterns are more likely the result of the changing ocean temperatures.

But what is causing the change in ocean temperatures? The "greenhouse effect" is what most people will say—but it does not explain why some parts of some oceans are heating up enormously, and some aren't.

Now, at last, science is starting to confirm that underwater volcanism is one of the biggest culprits in causing weather pattern change.

In late March, a CBS prime-time television special (hosted by Dan Rather) featured a story on El Niño. Presenting his most recent findings was scientist Daniel Walker, a marine seismologist at the School of Ocean and Earth Sciences and Technology and at the Institute of Geophysics and Planetology at the University of Hawaii.

After researching the El Niño phenomenon for some time, he concludes that the real generating force behind El Niño is underwater volcanism.

(Source: Earth Changes Report, May 1998)

EXTRA CASH FOR FARMERS WHO GO ORGANIC!

Britain's agricultural, environmental and water experts are so concerned at the impact of chemical sprays and fertilisers that they are coming up with schemes to offer cash and other incentives to farmers who convert to organic farming practices.

One water company, Wessex Water, has offered to pay farmers £16 an acre to switch to organic farming, in what is believed to be the first incentive of its kind from the water industry. The company will be spending £400,000 over the next two years in an attempt to stem the increasing levels of nitrates which have been leaking into the water from neighbouring farmland.

On top of this, Agriculture Minister Jack Cunningham has announced an extra

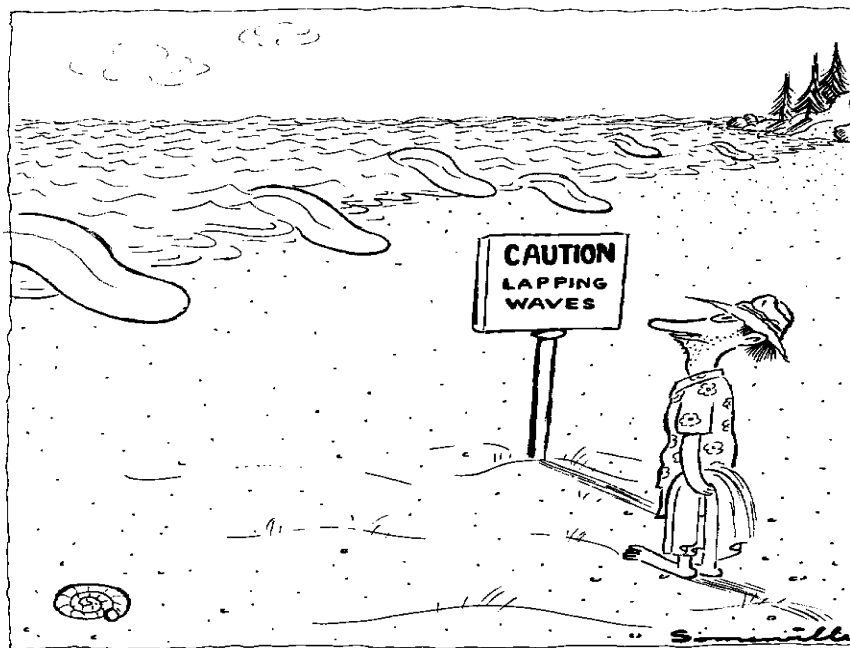

... GLOBAL NEWS ...

£337,000 for organic research and more cash subsidies for farmers converting to organic farming, in a plan to extend the areas of Britain farmed without sprays or artificial fertilisers.

(Sources: The Daily Telegraph, UK, 6 April, 1998; Weekly Telegraph, 15-21 April 1998)

AIDS AND CHRONIC ILLNESSES CURED WITH POLYATOMIC OXYGEN THERAPY

We continue to receive enquiries from readers as to whatever happened to Basil Wainwright, the inventor of the Polyatomic Apheresis Unit. His dialysis-type machine was successfully used to ozonate blood and had remarkable results with the treatment of AIDS and cancer.

NEXUS readers may recall that Basil was imprisoned in Florida under trumped-up charges in order to suppress his radical but simple ozone therapy treatment. Australian current affairs television programs also willingly put the boot into Basil's research, opting to overlook his successes and focus on any controversy they could find (or create). A researcher from *A Current Affair* admitted to me: "Our brief is to hang Basil Wainwright out to dry."

Despite several attempts on his life in prison, Basil was freed. He was invited to Nairobi, Kenya, where after a few years of conducting treatments and research he has collected documentation for 52 HIV-positive patients converted to PCR-undetectable status, i.e., clinical reversal of AIDS. During one well-documented 12-

month program, some patients actually became P24-antibody-negative.

Because of these impressive results, Basil Wainwright and research virologist/biologist Alfred Adema have been invited to speak at the 12th World AIDS Conference in Geneva, Switzerland (28 June to 3 July 1998).

The research team has been so successful in reversing not only AIDS but also cancer, malaria and "sleeping sickness", that the Polyatomic Apheresis Research Group has set up two mobile treatment centres and is now treating more than 3,000 Kenyans per week, completely free of charge. The group has also established a division in Johannesburg, South Africa, where polyatomic apheresis has been used to reverse a number of lupus conditions.

Copies of the above medical data are available to other professional research entities. Contact Polyatomic Apheresis Research Ltd, PO Box 15120, Nairobi, Kenya, phone/fax +254 88 4466.

OXYGEN ACTIVIST ED McCABE NOW A POLITICAL PRISONER

Ed McCabe, the investigative journalist who has spent years researching, lecturing on and advocating the benefits of increased oxygenation in the human body, has been imprisoned on what appear to be totally trumped-up tax charges.

Threatened with a 17-year jail term, plus a US\$250,000 fine, Ed has been "told" that "they" don't like what he's doing. Even more sinister is the fact that the Feds are

using Internet discussion groups on oxygen therapies to try to gather evidence that Ed is "taking advantage of sick people".

Ed has refused to lodge a plea, has refused legal counsel and is being held without a hearing. Technically speaking, Ed McCabe is now a political prisoner in Syracuse County Jail in Syracuse, NY.

NEXUS paid for Ed to visit Australia in 1992. He brought documentation on several AIDS patients who had gone from HIV-positive to HIV-negative as a result of oxygen therapies. All were invited to see and debate the documents, but the media, the medicos and the AIDS councils were not the least bit interested. (Incidentally, Dr James Boyce, the doctor who conducted these successful treatments, was also framed and imprisoned for his efforts.)

Awareness and appreciation of the benefits of oxygen therapies have increased enormously around the world, and much of this is due to Ed McCabe's tireless and mostly unpaid promotional work. Ed's hectic lifestyle has already cost him his family and house, and has driven him broke. Now it has cost him his freedom.

A campaign has been set up to press for Edward Joseph McCabe's release. Anyone who would like to assist is urged to subscribe to the oxygen therapies e-mail list, list@oxytherapy.com, or telephone supporter Howard Griswald on (302) 875 2653 in the USA as soon as possible.

US MASSACRE OF SOMALIS COVERED UP

In 1993, US "peacekeepers" in Somalia massacred more than 1,000 people, including civilians and children, in a single afternoon. While the Western media focused on the deaths of 18 US soldiers and showed pictures of a dead pilot being dragged through the streets of Mogadishu, the fact that hundreds of Somali women and children were slaughtered was barely mentioned at all.

While researching a book on the US occupation of Somalia, Mark Bowden from the *Philadelphia Inquirer* interviewed former US soldiers, aid officials and Somali witnesses. His findings were published in the London *Observer* on 22 March.

Bowden revealed that on 3 October 1993, US forces got word that leaders of General Aideed's group were meeting in a house in central Mogadishu. A squad of 40 Delta Special Forces soldiers and about 75 Rangers plus 17 helicopter gunships

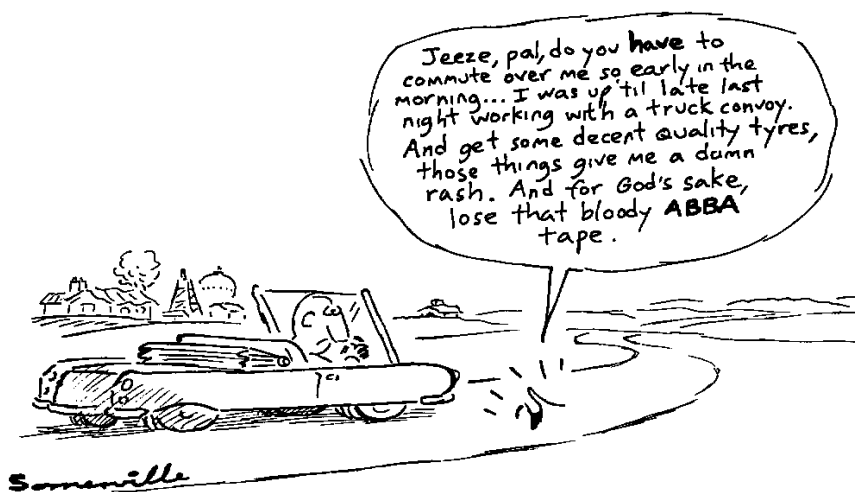

ROAD RAGE

attacked houses thought to contain the leaders. The operation was *not* approved by UN commanders.

The helicopter gunships began the raid by firing anti-tank missiles into houses in the immediate vicinity of the target. The US troops then stormed the houses, took 24 prisoners and attempted to return the five or so kilometres to base.

The raid triggered a mass uprising in the area. At every turn the troops were met by hundreds of angry civilians and armed Somali fighters who shot down two Blackhawk gunships, killing the 18 US troops. In their attempts to escape the ever-growing crowds, the US forces panicked and shot anyone and anything. Eventually the trapped soldiers were rescued by Malaysian and Pakistani troops.

In one incident, US troops took a whole family hostage. When one of them began to scream, she was shot dead.

In another incident, a Somali hostage was shot dead when he refused to stop praying. It was also widely reported that the US troops murdered the wounded Somalis and used their bodies as barricades.

To this day, the US has never held any public investigation or reprimanded any of its commanders or troops.

(Sources: Guardian Weekly, UK, 29 March 1998; Green Left Weekly, Aust, 8 April 1998)

SEED GERMINATION OR TERMINATION?

They call it "terminator technology", a "breakthrough" in genetic engineering. It is the seed that doesn't germinate. If adopted, it means that the tradition of saving seeds from one crop for the next season's planting will disappear.

In early March 1998, the US Department of Agriculture (USDA) and a Mississippi seed company, the Delta and Pine Land Company, were granted a patent for a technique that can sterilise the seeds produced by most agricultural crops.

They expect the technology to be adopted by all the major seed companies which for many years have been looking for ways to prevent farmers from recycling seeds from their crops.

Willard Phelps, a spokesman for the USDA, predicts the new technique will soon be so widely adopted that farmers will only be able to buy seeds that cannot be re-germinated.

(Source: New Scientist, 28 March 1998)

THE CANCER RISKS FROM rBGH IN MILK

Two veteran news reporters for Fox TV in Tampa, Florida, have been fired for refusing to water-down an investigative report on Monsanto's controversial milk hormone, rBGH (recombinant bovine growth hormone or bovine somatotropin, rBST).

Monsanto sells the genetically engineered hormone rBGH to dairy farmers who inject it into their cows every two weeks to increase milk production. In recent years, evidence has accumulated indicating that rBGH may promote cancer in humans who drink milk from rBGH-treated cows. It is the link between rBGH and cancer that Fox TV tried hardest to remove from the story.

In the fall of 1996, award-winning reporters Steve Wilson and Jane Akre were hired by WTVT in Tampa to produce a series on rBGH in Florida milk. After more than a year's work on the rBGH series, and three days before the first broadcast scheduled for 24 February 1997, Fox TV executives received the first of two letters from lawyers representing Monsanto, saying that Monsanto would suffer "enormous damage" if the series went to air. WTVT had been advertising the series aggressively, but cancelled it at the last moment. Monsanto's second letter warned of "dire consequences" for Fox if the series aired as it stood. (How Monsanto knew the series content remains a mystery.)

According to documents filed in Florida's Circuit Court (13th Circuit), Fox lawyers then tried to water-down the series, offering to pay the two reporters if they would leave the station and 'keep mum' about what Fox had done to their work. The reporters refused Fox's offer, and on 2 April 1998 they filed their own lawsuit against WTVT.

Steve Wilson has 26 years' experience as a journalist and has won four Emmy awards for his investigative reporting. His wife, Jane Akre, has been a reporter and news anchor for 20 years and has won a prestigious Associated Press award for her investigative reporting.

The Wilson/Akre lawsuit charges that WTVT violated its licence from the Federal Communications Commission (FCC) by demanding that the reporters include known falsehoods in their rBGH series. The reporters also charge that WTVT violated Florida's 'whistle-blower' law. Many of the legal documents in the lawsuit—including Monsanto's threatening letters—have been posted on the world wide web at www.foxbghsuit.com for all to see.

No one will be surprised to learn that powerful corporations can intimidate TV stations into rewriting the news, but this case offers an unusually detailed glimpse of specific intimidation tactics and their effects inside a news organisation.

It has been well documented by Monsanto and others that rBGH-treated cows undergo several changes: their lives are shortened, they are more likely to develop mastitis (an infection of the udder which then requires use of antibiotics which end up in the milk along with increased pus), and they produce milk containing elevated levels of another hormone, IGF-1.

It is IGF-1 that is associated with increased likelihood of human cancers. IGF-1 is a naturally occurring hormone protein that is chemically identical in cows and humans. However, IGF-1 in milk is not destroyed by pasteurisation. Because it is active in humans and causes cells to divide, any increase in IGF-1 in milk raises obvious questions: will it cause inappropriate cell division and growth leading to growth of tumours?

The US Food and Drug Administration (FDA) approved rBGH for use in cows in 1993, but the approval process was controversial because former Monsanto employees went to work for the FDA, oversaw the approval process, then went back to work for Monsanto. Milk containing rBGH was never properly tested on humans before the FDA allowed it onto the market.

Monsanto is notorious for marketing dangerous products while falsely claiming safety. The entire planet is now contaminated with hormone-disrupting, cancer-causing PCBs (polychlorinated biphenyls), thanks to Monsanto's refusal to be guided by early scientific evidence indicating harm. Critics say rBGH is just one more example of Monsanto's monumentally poor judgement. When Wilson and Akre asked Monsanto officials to respond to these allegations of past poor judgement, Monsanto had no comment.

(Source: Rachel's Environment & Health Weekly, no. 593, 9 April 1998; Environmental Research Foundation, PO Box 5036, Annapolis, MD 21403, USA. Full citations for this article can be found at Rachel's archive, www.monitor.net/rachel/)

The Hidden History of Jesus and the Holy Grail

The early Christian Church leaders adopted scriptures and teachings that would deliberately obscure the truth about the royal bloodline of Jesus.

Part 3

From a lecture presented by
Sir Laurence Gardner, Kt St Gm, KCD
Author of *Bloodline of the Holy Grail*
at The Ranch, Yelm, Washington, USA
30 April 1997
Transcript © Sir Laurence Gardner 1997-98

We know from the Gospel chronology that the Bethany second-marriage anointing of Jesus by Mary Magdalene was in the week before the Crucifixion. And we know that at that stage Mary was three-months pregnant and therefore should have given birth in the following September.

So, what do the Gospels tell us about events in September AD 33? In fact, the Gospels tell us nothing, but the story is taken up in The Acts of the Apostles which detail for September the event which we have come to know as "the Ascension".

The one thing that the Acts do not do, however, is call the event "the Ascension". This was a name given to the ritual when the Roman Church doctrines were established over three centuries later. What the text actually says is: "And when he had spoken these things...he was taken up, and a cloud received him out of their sight." It then continues that "a man in white" said to the disciples: "Why stand ye gazing up into heaven? This same Jesus...shall so come in like manner as ye have seen him go." Then, a little later in the Acts, it says that "heaven" must receive Jesus until "the time of restitution".

Given that this was the very month in which Mary Magdalene's child was due, is there perhaps some connection between Mary's confinement and the so-called Ascension? There certainly is, and the connection is made by virtue of the time of restitution.

Not only were there rules to govern the marriage ceremony of a Messianic heir, but so too were there rules to govern the marriage itself. The rules of dynastic wedlock were quite unlike the Jewish family norm, and Messianic parents were formally separated at the birth of a child. Even prior to this, intimacy between a dynastic husband and wife was only allowed in December, so that births of heirs would always fall in the month of September—the month of Atonement, the holiest month of the Jewish calendar.

Indeed, it was this very rule which Jesus's own parents (Joseph and Mary) had themselves broken. And this was the reason why the Jews were split in opinion as to whether Jesus was, in fact, their true Messiah.

When a dynastic child was conceived at the wrong time of year, the mother was generally placed in monastic custody for the birth so as to avoid public embarrassment. This was called being "put away privily", and Matthew states quite plainly that when Mary's pregnancy was discovered, "Joseph, her husband, being a just man and not willing to make her a public example, was minded to put her away privily".

In this instance, special dispensation for the birth was granted by the archangel Simeon who at that time held the distinction of "Gabriel", being the angelic priest in charge. Both the Dead Sea Scrolls and the Book of Enoch (which was excluded from the Old Testament) detail that the "archangels" (or chief ambassadors) were the senior priests at Qumran, retaining the traditional titles of "Michael", "Gabriel", "Raphael", "Sariel", etc.

In the case of Jesus and Mary Magdalene, however, the rules of wedlock had been obeyed to the letter, and their first child was properly conceived in December AD 32, to be born in September AD 33.

From the moment of a dynastic birth, the parents were physically separated—for six years if the child was a boy, and for three years if the child was a girl. Their marriage would only be recommenced at the designated time of restitution. Meanwhile, the mother and child would enter the equivalent of a convent, and the father would enter "the Kingdom of Heaven". This Kingdom of Heaven was actually the Essene High Monastery at Mird, by the Dead Sea, and the ceremony of entry was conducted by the angelic priests under the supervision of the appointed Leader of the Pilgrims.

In the Old Testament book of Exodus, the Israelite pilgrims were led into the Holy

Land by a "cloud"—and in accordance with this continued Exodus imagery, the priestly Leader of the Pilgrims was designated with the title "Cloud".

So, if we now read the Acts verses as they were intended to be understood, we see that Jesus was taken up by the Cloud (the Leader of the Pilgrims) to the Kingdom of Heaven (the High Monastery). And the man in white (an angelic priest) said that Jesus would return at the time of restitution (when his Earthly marriage was restored).

If we now look at St Paul's Epistle to the Hebrews we discover that he explains the said Ascension event in some greater detail, for Paul tells of how Jesus was admitted to the Priesthood of Heaven when he actually had no entitlement to such a sacred office. He explains that Jesus was born (through his father Joseph) into the Davidic line of Judah—a line which held the right of kingship but had no right to priesthood, for this was the sole prerogative of the line of Aaron and Levi.

But, says Paul, a special dispensation was granted, and he tells that "for the priesthood being changed, there is made of necessity a change also of the law". As a result of this express "change of the law", it is explained that Jesus was enabled to enter the Kingdom of Heaven in the priestly Order of Melchizedek.

So, in September AD 33, the first child of Jesus and Mary Magdalene was born, and Jesus duly entered the Kingdom of Heaven. There is no reference to this child being a son (as there is for the two subsequent births), and given that Jesus returned three years later, in AD 36, we know that Mary must have had a daughter.

By following the chronology of the Acts, we see that in September AD 37 a second child was born; and then

another in AD 44. The period between these two births to the second restitution in AD 43 was "six years", which denotes that the AD 37 child was a son. This fact is also conveyed by the use of cryptic wording—the same cryptic wording afforded to the AD 44 child—so we know that this third child was also a son.

In accordance with the scribal codes detailed in the Dead Sea Scrolls, everything cryptic within the New Testament is set up beforehand by some other entry which explains that the inherent message is "for those with ears to hear". Once these codes and allegories are understood, they never ever vary. They mean the same thing every time they are used, and they are used every time that same meaning is required.

For example, the Gospels explain that Jesus was called "the Word of God": "And the Word was made flesh, and dwelt among us...full of grace and truth." John goes to great lengths to explain the relevance of this definition, and subsequent entries give details such as "the Word of God stood by the lake" and "the Word of God was in Samaria".

Messages conveying information about fertility and new life are established in the Parable of the Sower whose seed "bore fruit and increased". Thus, when it is said that "the Word of God increased", "those with ears to hear" would recognise at once that "Jesus increased"—that is to say, he had a son. There are two such entries in the Acts, and they fall precisely on cue in AD 37 and AD 44.

Probably the most misrepresented book of the New Testament is The Book of The Revelation of St John the Divine—misrepre-

sented by the Church, that is; not by the book itself. This book is quite unlike any other in the Bible. It is dubbed with terrible supernatural overtones, and its straightforward imagery has been savagely corrupted by the Church to present the text as some form of foreboding or prophecy of warning! But the book is not called "The Prophecy" or "The Warning". It is called "The Revelation".

So, what does the book reveal? Chronologically, its story follows The Acts of the Apostles, and the Book of The Revelation is, in fact, the continuing story of Jesus, Mary Magdalene and their sons, particularly the elder son, Jesus Justus. It follows his life and details his marriage, along with the birth of his own son. This much-misunderstood New Testament book is not a foreboding or a warning as the fearful Church would have us believe. It is precisely what it says it is: a revelation.

As we saw earlier, ordained priests of the era were called "fishers"; their helpers were called "fishermen", and baptismal candidates were called "fishes". Jesus became an ordained fisher when he entered the Kingdom of Heaven, but until that time (as explained by St Paul) he held no priestly office.

In the rite of ordination, the officiating Levite priests of the Sanctuary would administer five loaves of bread and two fishes to the candidates, but the law was very firm in that such candidates had to be circumcised Jews. Gentiles and uncircumcised Samaritans were on no account afforded any such privilege.

Indeed, it was this particular ministerial ritual which Jesus had flouted at the so-called "feeding of the five-thousand", because he presumed the right to grant access to his own new liberal ministry by offering the loaves and fishes to an unsanctified

gathering. Apart from eventually becoming a fisher, Jesus was also referred to as "the Christ"—a Greek definition which meant "the King". In saying the name "Jesus Christ", we are actually saying "King Jesus", and his kingly heritage was of the Royal House of Judah (the House of David), as mentioned numerous times in the Gospels and in the Epistles of St Paul.

From AD 33, therefore, Jesus emerged with the dual status of a "Priest Christ" or, as is more commonly cited, a "Fisher King". This definition, as we shall see, was to become an hereditary and dynastic office of Jesus' heirs, and the succeeding "Fisher Kings" were paramount in the history of the Grail bloodline.

Prior to the birth of her second son in AD 44, Mary Magdalene was exiled from Judaea following a political uprising in which she was implicated. Along with Philip, Lazarus and a few retainers, she travelled (by arrangement with King Herod-Agrippa II) to live at the Herodian estate near Lyon, in Gaul (which later became France).

From the earliest times, through the mediaeval era, to the great Renaissance, Mary's flight was portrayed in illuminated manuscripts and great artworks alike. Her life and work in France, especially in Provence and the Languedoc, appeared not only in works of European history but also in the Roman Church liturgy—until her story was suppressed by the Vatican.

Mary Magdalene's exile is told in The Book of The Revelation which describes that she was pregnant at the time. It tells also of how the Roman authorities subsequently persecuted Mary, her

Prior to the birth of her second son in AD 44, Mary Magdalene was exiled from Judaea following a political uprising in which she was implicated.

son and his heirs: "And she, being with child, cried...and pained to be delivered...and behold, a great red dragon, having seven heads...and seven crowns...stood before the woman...for to devour her child... And she brought forth a man-child...and the woman fled into the wilderness... And the dragon was wroth with the woman, and went to make war forever with the remnant of her seed...which...have the testimony of Jesus Christ."

It was to Gaul that Mary was said to have carried the *Sangréal* (the Blood Royal, the Holy Grail); and it was in Gaul that the famous line of Jesus and Mary's immediate descendant heirs, the Fisher Kings, flourished for 300 years.

The eternal motto of the Fisher Kings was "In Strength"—inspired by the name of their ancestor, Boaz (the great-grandfather of King David), whose name similarly meant "In Strength". When translated into Latin, this became "In Fortis", which was subsequently corrupted to "Anfortas", the name of the Fisher King in Grail romance.

We can now return to the Grail's traditional symbolism as a chalice containing the blood of Jesus. We can also consider graphic designs dating back well beyond the Dark Ages to about 3,500 BC. And in doing this, we discover that a chalice or a cup was the longest-standing symbol of the female. Its representation was that of the Sacred Vessel—the *vas uterus*, the womb.

And so, when fleeing into France, Mary Magdalene carried the *Sangréal* in the Sacred Chalice of her womb—just as the Book of The Revelation explains. And the name of this second son was Joseph.

The equivalent traditional symbol of the male was a blade or a horn, usually represented by a sword or a unicorn. In the Old Testament's Song of Solomon and in the Psalms of David, the fertile unicorn is associated with the kingly line of Judah; and it was for this very reason that the Cathars of Provence used the mystical beast to symbolise the Grail bloodline.

Mary Magdalene died in Provence in AD 63. In that very year, Joseph of Arimathea built the famous chapel at Glastonbury in England as a memorial to the Messianic Queen. This was the first 'above-ground' Christian church in the world, and in the following year Mary's son Jesus Justus dedicated it to his mother. Jesus the Younger had in fact been to England with Joseph before, at the age of twelve, in AD 49. It was this event which inspired William Blake's famous song, *Jerusalem*: "And did those feet in ancient time, walk upon England's mountains green."

But who was Joseph of Arimathea, the man who assumed full control of affairs at the Crucifixion? And why was it that Jesus' mother, his wife and the rest of the family accepted Joseph's intervention without question?

As late as the year 900, the Church of Rome decided to announce that Joseph of Arimathea was the uncle of Jesus' mother Mary. And from that time, portrayals of Joseph have shown him as being rather elderly at the Crucifixion, when Mother Mary was herself in her fifties. Prior to the Roman announcement, however, the historical records of Joseph depicted a much younger man.

He was recorded to have died at the age of 80 on 27 July AD 82, and thus would have been aged 32 at the time of the Crucifixion.

In fact, Joseph of Arimathea was none other than Jesus Christ's own brother, James, and his title had nothing whatever to do with a place name. Arimathea never existed. It therefore comes as no surprise that Joseph negotiated with Pilate to place Jesus in his own family tomb.

The hereditary "Arimathea" title was an English corruption of the Graeco-Hebrew style *ha-Rama-Theo*, meaning "of the Divine Highness", or "of the Royal Highness" as we'd define it today. Since Jesus was the senior Messianic heir—the Christ, *Khristos* or King—then his younger brother was the Crown Prince—the Royal Highness, *Rama-Theo*. In the Nazarene hierarchy, the Crown Prince always held the patriarchal title of "Joseph"—just as Jesus was a titular "David" and his wife was a "Mary".

The descendant heirs of Jesus posed an enormous threat to the Roman High Church because they were the dynastic leaders of the true Nazarene Church.

In the early fifth century, Jesus and Mary's descendent Fisher Kings became united by marriage to the Sicambrian Franks, and from them emerged a whole new 'reigning' dynasty. They were the noted Merovingian Kings who founded the French monarchy and introduced the well-known *fleur-de-lys* (the ancient Jewish symbol of circumcision) as the royal emblem of France.

From the Merovingian succession, another strain of the family established a wholly independent Jewish kingdom in southern France: the Kingdom of Septimania, which we now know as the Languedoc. And the early princes of Toulouse, Aquitaine and Provence were all descended in the Messianic bloodline of the Holy Grail. Septimania was granted to the Royal House of David in 768, and Prince Bernard of Septimania later married a daughter of Emperor Charlemagne.

Also from the Fisher Kings came another important parallel line of succession in Gaul. Whereas the Merovingian Kings continued the patriarchal 'male' heritage of Jesus, this other line perpetuated the matriarchal heritage of Mary Magdalene in a 'female' line. They were the dynastic Queens of Avallon in Burgundy, the House del Acqs—meaning "of the waters", a style granted to Mary Magdalene in the early days when she voyaged on the sea to Provence.

Those familiar with Arthurian and Grail lore will by now have recognised the ultimate significance of this Messianic family of the Fisher Kings, the Queens of Avallon and the House del Acqs (corrupted in Arthurian romance to "du Lac").

The descendant heirs of Jesus posed an enormous threat to the Roman High Church because they were the dynastic leaders of the true Nazarene Church. In real terms, the Roman Church should never have existed at all, for it was no more than a 'hybrid' movement comprised of various pagan doctrines attached to a fundamentally Jewish base.

Jesus was born in 7 BC and his birthday was on the equivalent of 1 March, with an 'official' royal birthday on 15 September to comply with dynastic regulation. But, when establishing the Roman High Church in the fourth century, Emperor Constantine

ignored both of these dates and supplemented 25 December as the new Christ's Mass Day—to coincide with the pagan Sun Festival.

Later, at the Synod of Whitby in 664, the bishops expropriated the Celtic festival of Easter (Eostre), the Goddess of Spring and Fertility, and attached a wholly new Christian significance. In so doing, they changed the date of the Celtic festival to sever its traditional association with the Jewish Passover.

Christianity, as we know it, has evolved as a 'composite religion' quite unlike any other. If Jesus was its living catalyst, then Christianity should rightly be based on the teachings of Jesus himself—the moral and social codes of a fair-minded, tolerant ministry, with the people as its benefactors.

But orthodox Christianity is not based on the teachings of Jesus: it is based on the teachings of the Roman Church, which are entirely different. There are a number of reasons for this, the foremost of which is that Jesus was deliberately sidestepped in favour of the alternative teachings of Peter and Paul—teachings which were thoroughly denounced by the Nazarene Church of Jesus and his brother James.

Only by removing Jesus from the front-line could the Popes and cardinals reign supreme. When formally instituting Christianity as the state religion of Rome, Constantine declared that "he alone" was the true "Saviour Messiah", not Jesus! As for the Bishops of Rome (the Popes), they were granted an apostolic descent from St Peter—not a legitimate Desposynic descent from Jesus and his brothers, as was retained within the Nazarene Church.

The only way for the Roman High Church to restrain the heirs of Mary Magdalene was to discredit Mary herself and to deny her bridal relationship with Jesus. But what of Jesus' brother James? He, too, had heirs, as did their other brothers, Simon, Joses and Jude.

The Church could not escape the Gospels which state that Jesus was the Blessed Mother Mary's "first-born son", and so Mary's own motherhood also had to be repressed.

As a result, the Church portrayed Mother Mary as a virgin, and Mary Magdalene as a whore—neither of which description was mentioned in any original Gospel. Then, just to cement Mother Mary's position outside the natural domain, her own mother, Anna, was eventually said to have borne her by way of "Immaculate Conception"!

Over the course of time, these contrived doctrines have had widespread effect. But, in the early days, it took rather more to cement the ideas because the original women of the Nazarene mission had a significant following in the Celtic Church—women such as Mary Magdalene, Martha, Mary Jacob-Cleophas and Helena-Salome who had run schools and social missions throughout the Mediterranean world. These women had all been disciples of Jesus, and close friends of his mother, Mary, accompanying her to the Crucifixion, as confirmed in the Gospels.

The Church's only salvation was to deny women altogether; to deny them not only rights to ecclesiastical office, but to deny

them rights to any status in society. Hence, the Church declared that women were all heretics and sorceresses!

In this, the bishops were aided by the words of Peter and Paul, and on the basis of their teachings the Roman High Church was enabled to become wholly sexist. In his Epistle to Timothy, Paul wrote: "I suffer not a woman to teach, nor to usurp any authority over the man, but to be in silence." In the Gospel of Philip, Peter is even quoted as saying that "Women are not worthy of life". The bishops even quoted the words of Genesis, wherein God spoke to Eve about Adam, saying "He shall rule over thee".

The Church Father Tertullian summed up the whole Roman

attitude when writing about the emergent disciples of Mary Magdalene: "These heretical woman! How dare they! They are brazen enough to teach, to engage in argument, to baptise... It is not permitted for a woman to speak in church...nor to claim...a share in any masculine function—least of all in priestly office."

Then, to cap it all, came the Roman Church's most amazing document, *The Apostolic Order*. This was compiled as an 'imaginary' conversation between the apostles after the Last Supper. Contrary to the Gospels, it supposed that Mary Magdalene had been present at the Supper, and it was agreed that the reason why Jesus had not passed any wine to Mary at the table was because he had seen her laughing!

On the basis of this extraordinary, fictitious document, the bishops ruled that, even though Mary might have been a companion of Jesus, women were not to be afforded any place within the Church because they were not serious! This sexist attitude has persisted within the Church to the present day. Why? Because Mary Magdalene had to be discredited and removed from the reckoning so that her heirs could be ignored. But things are now changing, and, in the Anglican Church at least, women are being restored to the priestly station.

Only by removing Jesus from the frontline could the Popes and cardinals reign supreme. When formally instituting Christianity as the state religion of Rome, Constantine declared that "he alone" was the true "Saviour Messiah", not Jesus!

Notwithstanding the avid sexist movement, the Messianic heirs retained their social positions outside the Roman Church establishment. They progressed their own Nazarene and Celtic Church movements and founded Desposynic kingdoms in Britain and Europe. They were a constant threat to the Roman High Church and to the figurehead monarchs and governments empowered by that Church. They were the very reason for the implementation of the brutal Inquisition because they upheld a moral and social code which was contrary to High Church requirement.

This was especially apparent during the Age of Chivalry, which embraced a respect for womanhood, as exemplified by the Knights Templars whose constitutional oath supported a veneration of "the Grail Mother", Queen Mary Magdalene.

Prior to the Middle Ages, the individual stories of this family were historically well-known. But when the Church began its reign of fanatical persecution (the great Inquisition), the whole Nazarene and Desposynic heritage was forced underground.

But why the vengeful onset of the Inquisition? Because the

Knights Templars had not only returned from the Holy Land with documents that undermined the Church's teachings, but they also established their own Cistercian churches in opposition to Rome. These were not just any churches; they were the greatest religious monuments ever to grace the skylines of the western world: the *Notre Dame* cathedrals of France.

Despite their present-day image, these impressive Gothic cathedrals had nothing whatever to do with the established Christian Church. They were funded and built by the Knights Templars, and they were dedicated to Mary Magdalene—*Notre Dame, Our Lady*—whom they called "the Grail of the world".

This, of course, defeated every dogma that the High Church had encouraged, and the bishops retaliated by re-dedicating numerous other churches to Mary, the mother of Jesus. But, in so doing, they made a strict decree that all artistic portrayals of Mother Mary, the Madonna, must henceforth show her dressed in "blue and white only"—so as not to grant her any rights to ecclesiastical office in the male-only priesthood.

Mary Magdalene, on the other hand, was being portrayed (by the world's greatest artists) wearing the red mantle of cardinal status or the black robe of a Nazarene High Priestess—and there was nothing the Church could do about it. The bishops' only option was to proclaim the practice sinful and heretical—because, in having previously elected to ignore Mary Magdalene and her heirs, she was outside their jurisdiction.

It was at that time that Grail lore was itself denounced as a heresy by the Vatican. The sixth-century writings of Merlin were expressly banned by the Ecumenical Council, and the original Nazarene Church of Jesus became an "underground stream", aided by such notable sponsors as Leonardo da Vinci and Sandro Botticelli.

In those days, the Church policed and controlled most literature in the public domain; and so, in order to avoid outright censorship, the Grail tradition became allegorical and its message was communicated by way of secret watermarks, esoteric writings, Tarot cards and symbolic artwork.

But why should Grail lore and the writings of Merlin have posed such a problem for the High Church? Because, within the context of their adventurous texts, they told the descendant story of the Grail bloodline—a bloodline which had been ousted from its dynastic position by the Popes and Bishops of Rome who had elected to reign supreme by way of a contrived "apostolic succession".

This apostolic succession was said to have been handed down from the first bishop, St Peter (and, indeed, this is still the promoted view). But one only has to study the Church's own *Apostolic Constitutions* to discover that this is simply not true. Peter was never a Bishop of Rome—nor of anywhere else, for that matter!

The Vatican's *Constitutions* record that the first Bishop of Rome was Prince Linus of Britain, the son of Caractacus the Pendragon. He was installed by St Paul in AD 58, during Peter's own lifetime.

From the 1100s, the powerful Knights Templars and their cathedrals posed an enormous threat to the 'male-only' Church by bringing the heritage of Jesus and Mary Magdalene to the fore in the public domain.

The cardinals knew that their whole establishment would tumble if the Messianic descendants gained the upper hand. They had to be crushed! And so the brutal Inquisition was implemented—a hideous persecution of all who dissented from the rule of the bishops.

It all began in 1208, when Pope Innocent III sent 30,000 soldiers into the Languedoc region of southern France. This was the home of the Cathars ("the Pure Ones") who were said to be the guardians of a great and sacred treasure—a mysterious secret which could overturn orthodox Christianity. The Pope's so-called Albigensian Crusade lasted for 36 years—during which time, tens of thousands of innocent people were slaughtered—but the treasure was never found.

The main thrust of the Inquisition (or "Holy Office") was instituted by Pope Gregory IX during the course of this massacre, in 1231, and it was set against anyone who supported "the Grail heresy". By 1252, the torture of victims was formally authorised, along with execution by burning.

"Heresy" was a wonderful charge to level against captives, because only the Church could define it. The victims were tortured until they confessed, and having confessed they were executed. If they did not confess, then the torture continued until they died anyway. One recorded form of torture was to spread the victim, little by little, with fat (beginning with his feet), and then to roast him alive in sections, limb by limb, over an open fire.

These savage persecutions and punishments were openly waged for more than 400 years, and were also extended against Jews, Muslims and Protestant dissenters. But the Inquisition was never formally terminated. As recently as 1965 it was renamed "the Sacred Congregation", and its powers are theo-

retically still in force today.

Undaunted by the Inquisition, the Nazarene movement pursued its own course, and the story of the bloodline was perpetuated in literature such as the *Grand Saint Grail* and the *High History of the Holy Grail*. These writings were largely sponsored by the Grail courts of France (the courts of Champagne, Anjou and others), and also by the Knights Templars and the *Desposyni*; and, at that stage, Arthurian Romance became a popular vehicle for the Grail tradition.

In the light of this, the Templars became a specific target of the Inquisition in 1307 when the henchmen of Pope Clement V and King Philip IV of France were set in their direction. The papal armies scoured Europe for the Templar documents and treasure—but, like the Cathar inheritance, nothing was found. However, many Knights were tortured and executed in the process, and their companions escaped to countries outside the papal domain.

But the Templar hoard was not lost, and while the Vatican emissaries were searching, the treasure and documents were locked away in the Chapter House Treasury vaults of Paris. They

The sixth-century writings of Merlin were expressly banned by the Ecumenical Council, and the original Nazarene Church of Jesus became an "underground stream", aided by such notable sponsors as Leonardo da Vinci and Sandro Botticelli.

were under the protection of the Templar Grand Knights of St Anthony—"the Guardian Princes of the Royal Secret"—who loaded the hoard one night onto 18 galleys of the Templar fleet at La Rochelle.

By daybreak, the fleet had sailed for Scotland, and on arrival they were welcomed by King Robert the Bruce who, along with the whole Scottish nation, had been excommunicated by the Pope for challenging the Catholic King Edward of England. In Scotland, the Templars and their treasure remained, and the Knights fought with Bruce at Bannockburn in 1314 to regain Scotland's independence from Plantagenet England.

Subsequent to the Battle of Bannockburn, Bruce and the St Anthony Templars founded the new Order of the Elder Brothers of the Rosy Cross in 1317—from which time the Kings of Scots became hereditary Grand Masters, with each successive Stewart King holding the honoured Grand Priory title of "Prince Saint Germain".

So, why was it that King Arthur, a Celtic commander of the sixth century, was so important to the Knights Templars and the Grail courts of Europe? Quite simply, because Arthur had been unique, with a 'dual' heritage in the Messianic line.

King Arthur was by no means mythical, as many have supposed. Far from it. But he has generally been looked for in the wrong places. Researchers, misguided by the fictional locations of the romances, have searched in vain through the chronicles of Brittany, Wales and the west of England. But the details of Arthur are to be found in the Scots' and Irish annals. He was indeed "the High King of the Celtic Isle", and he was the sovereign commander of the British troops in the late sixth century.

Arthur was born in 559, and he died in battle in 603. His mother was Ygera del Acqs, the daughter of Queen Viviane of Avallon, in descent from Jesus and Mary Magdalene. His father was High King Aedàn of Dalriada (the Western Highlands of Scotland, now called Argyll)—and Aedàn was the British Pendragon ("Head Dragon" or "King of Kings") in descent from Jesus' brother James. It is for this reason that the stories of Arthur and Joseph of Arimathea are so closely entwined in the Grail romances.

Indeed, the coronation records of Scotland's King Kenneth MacAlpin (a descendant of Aedàn the Pendragon) specifically refer to his own descent from the dynastic Queens of Avallon.

King Aedàn's paternal legacy emerged through the most ancient House of Camulot (England's Royal Court of Colchester) in a line from the first Pendragon, King Cymbeline (who is well-known to students of Shakespeare).

By that time, Messianic descendants had founded Desposynic kingdoms in Wales and across the Strathclyde and Cambrian regions of Britain. Arthur's father, King Aedàn of Scots, was the first British monarch to be installed by priestly ordination, when he was crowned and anointed by Saint Columba of the Celtic Church in 574. This, of course, infuriated the Roman Church bishops because they claimed the sole right to appoint kings who

were supposed to be crowned by the Pope!

As a direct result of this coronation, Saint Augustine was eventually sent from Rome in 597 to dismantle the Celtic Church. He proclaimed himself Archbishop of Canterbury three years later, but his overall mission failed and the Nazarene tradition persisted in Scotland, Ireland and Wales and across the breadth of northern England.

An important fact to remember is that the Grail dynasts were never territorial governors of lands. Like Jesus himself, they were designated "Guardians" of the people. The Merovingians of Gaul, for example, were Kings of the Franks—never Kings of France. King Aedàn, Robert the Bruce and their Stewart successors were Kings of the Scots—never Kings of Scotland.

It was this implicitly 'social' concept which the High Church found so difficult to overcome, for the bishops preferred to have dominion over 'territorial kings', while the people's senior lord and master was supposed to be the Pope. Only by maintaining ultimate spiritual control over individuals could the Church reign supreme, and so whenever a Grail dynast came to the fore he was met by the wrath of the papal machine.

In 751 the bishops managed to depose the Merovingian succession in Gaul, and they established a new tradition whereby kings of the Carolingian succession (that of Charlemagne) had to be approved and crowned by the Pope. But the Church could never topple the Desposynic lines in Scotland, even though the old Celtic kingdoms of England had been dismantled by Germanic Anglo-Saxons from the sixth century.

Even into the Middle Ages—long after the Norman Conquest of England—the Nazarene Church and the long-prevailing cult of Mary Magdalene were prominent in Europe. Women's rights of equality were upheld throughout the Celtic structure—and this was an enormous problem for the male-only priesthood of orthodox Christianity.

Even into the Middle Ages—long after the Norman Conquest of England—the Nazarene Church and the long-prevailing cult of Mary Magdalene were prominent in Europe. Women's rights of equality were upheld throughout the Celtic structure—and this was an enormous problem for the male-only priesthood of orthodox Christianity.

The underlying principle of the Grail monarchs was always one of Service, in accordance with the Messianic code established by Jesus when he washed his apostles' feet at the Last Supper. And so the

true Grail dynasts were kings and guardians of their realms, but they were never rulers.

This key aspect of the Grail code was perpetuated at the very heart of nursery tale and folklore. Never did a valiant cardinal or bishop ride to the aid of an oppressed subject or a damsel in distress, for this has always been the social realm of Grail princes and their appointed knights.

The Grail code recognises advancement by merit and acknowledges community structure, but, above all, it is entirely democratic. Whether apprehended in its physical or spiritual dimension, the Grail belongs to leaders and followers alike. It also belongs to the land and the environment, requiring that all should be "as one" in a common, unified Service.

Only by maintaining ultimate spiritual control over individuals could the Church reign supreme, and so whenever a Grail dynast came to the fore he was met by the wrath of the papal machine.

Continued on page 83

VACCINE CONTAMINATION

Germ Warfare on Civilians?

Dr Leonard Horowitz suggests that the widespread incidence of weird cancers and auto-immune illnesses today is a result of large populations being inoculated with vaccines known by health authorities to be contaminated.

An Interview with
Leonard G. Horowitz, DMD, MA, MPH

by **Dr Roger G. Mazlen**
Host of the CFS Radio Show, USA
Recorded 15 March 1998
Website:
www.cfsaudio.4biz.net/cfsprev.htm

Dr Roger G. Mazlen: We have as our guest Dr Leonard Horowitz, a Harvard graduate, independent investigator and internationally known authority on public health education, who's the author of the best-selling book *Emerging Viruses: AIDS and Ebola*.

Why are we talking to Dr Horowitz? Simply, chronic fatigue syndrome (CFS) patients have a depressed immune system. They have immune deficiency. They have immune suppression. They are sitting ducks for any kind of new viruses, especially those with the ability to destroy the immune system. So, without any further ado, welcome to the show, Dr Horowitz.

Dr Leonard G. Horowitz: Thank you, Dr Mazlen. It's a great privilege and pleasure to be with you.

Dr Mazlen: Well, we're delighted that we're able to talk to you today. Let me let you start by introducing us to the general scope of your book.

Dr Horowitz: Well, I spent three years investigating a 1970 Department of Defense appropriations request for US\$10 million into a five-year study to develop immune-system-ravaging micro-organisms for germ warfare. I didn't believe at first that this was a legitimate document. Ultimately I tracked the money following a paper trail of scientific literature and government documents and I found that the money had gone to an organisation called Litton Bionetics. Did you ever hear of Litton microwave ovens?

Dr Mazlen: Surely.

Dr Horowitz: Well, they're also a subsidiary of a megamilitary weapons contracting firm and they had a medical subsidiary which was called Litton Bionetics. They were sixth on the list with major army biological weapons contractors during the late '60s and early '70s. And they commuted numerous immune-system-ravaging micro-organisms for germ warfare. They were the recipients of over US\$2 million a year to develop these types of micro-organisms, not only for biological weapons research and development but also for cancer research and vaccine research and development. So, that's basically the book. *Emerging Viruses: AIDS and Ebola* goes into who made these types of viruses—the AIDS-like, Ebola-like viruses—how they made them, virtually every step of the way, and why they made them. And then, most incredibly, I found and reprinted in black and white the US Government contracts which show you how much US taxpayers pay to finance these research efforts.

Dr Mazlen: Well, of course, this is a very serious concern to our listening audience—those who have chronic fatigue, or those who suspect they may have, or those who are not sure—because any new virus or any virus which has the ability to suppress immunity constitutes a major threat to these people and to the general public as well.

Now, in your book, and I'm going to quote you, on page 134 you say: "Putting all the facts together I now understood how humanly benign DNA monkey viruses, like SV40...and other common retrovirus vaccine contaminants like SFV, could have, over the period of a few decades, become RNA retroviruses that, through contaminated vaccines, spread to millions of people around the world." Could you amplify that a little bit for the audience?

Dr Horowitz: Certainly. The gist of the book and the warning of the book *Emerging Viruses: AIDS and Ebola* is that we have a Food and Drug Administration [FDA] that does not tell health scientists or health professionals or the public the truth about the contaminated vaccines or the methods by which the vaccines are prepared. For example, the oral polio vaccine is still, to this day, being prepared in contaminated monkey kidney tissues which are bringing with it a variety of not only monkey virus contaminants but also

the herpes-type viruses, such as simian cytomegalovirus, Epstein-Barr and herpes B, which we know are immune-system-suppressing types of viruses.

We know also that the vaccine that most plausibly delivered AIDS and possibly even chronic fatigue to the world—since they both broke out in the same year, 1978—was the 1974 experimental hepatitis B vaccine that was prepared in Merck, Sharpe & Dohme's laboratories, along with support from the Centers for Disease Control and the Food and Drug Administration. We know that this particular hepatitis B vaccine was partly prepared in contaminated monkeys that were shipped by Litton—again, a biological weapons contracting firm for the Department of Defense. And we know for a fact that the monkeys from which these vaccines were produced were contaminated. We even have testimonial by the man who created these vaccines to that effect. His name is Dr Maurice Hilleman, and he was Merck, Sharpe & Dohme's leading vaccine developer.

So they developed these vaccines partly in contaminated animals and then they inoculated them into human beings, and it was therefore an accident waiting to happen that we would have a variety of immune-system-related disorders including weird cancers and weird auto-immune illnesses that we have in epidemic proportions today.

Dr Mazlen: Well that, of course, brings up a lot of issues, but I want to go back to your book again where you quote an interview with Dr Hilleman by Edward Shorter, PhD [pages 484-5], where Hilleman said, "there were 40 different viruses in these vaccines anyway that we were inactivating", and Shorter responded, "But you weren't inactivating the [SV40, simian virus 40]..." And then Hilleman said, "No, that's right." And

he even went on to say, "But yellow fever vaccine had leukaemia virus in it, and you know this is in the days of very crude science."

So, here we now learn from the very statements they made that not only were there immune-damaging viruses, there were even viruses that could spread leukaemia virus. You do go into this in the book. You talk about cases of T-cell leukaemia. What about that, for example? Is there still some risk of that occurring?

Dr Horowitz: I believe so, Dr Mazlen. I believe that many of these risks still continue to this day. Let me give you an example. Today, the Food and Drug Administration, which we rely upon for both our personal and our children's health and safety, must turn a blind eye to as many as 100 monkey virus contaminants per dose of the oral polio vaccine that we're allegedly by law told we must give our children today. And I say "allegedly" because it's not true. We have spiritual and religious exemptions that you can

get, and it is actually voluntary, but they make it seem like you can't go to school or you can't get your children into schools or you can't work in, for example, healthcare settings without getting these vaccines—and that's not the truth.

But you see, the Food and Drug Administration must turn a blind eye to at least 100 of these contaminants per dose because their hands are tied by proprietary laws and non-disclosure agreements placed upon them by the pharmaceutical industry. In other words, they're muzzled by the drug makers. So they can't even tell

our scientists the true extent of the contaminations and the risks associated with the vaccines. Therefore, the physicians—who get most of their continuing medical education paid for by the pharmaceutical industry as well—never learn the truth; and subsequently, when they look at patients with running eyes and say that

these vaccines are "for your own good" or "for your children's own good", they believe it. And they're just basically brainwashed. They're like cult followers, but they don't even know who their cult leaders are in many cases.

Dr Mazlen: Well, we certainly don't get any real information on the process of vaccine-making in medical school. I mean, there really isn't anything in the curriculum. I don't remember anything in the curriculum that applies to that whatsoever; and so, as you say, it's a *fait accompli*. You are just told to do it. It's good and you do it. This changes the whole picture, because in good conscience you wouldn't be giving something if you knew that it was contaminated with something that's detrimental.

Now we're going to talk a little bit about the work that's been done by W. John Martin and how it fits into this book. Dr W. John Martin, MD, PhD, wrote the foreword to this book and there's a section in it in which Dr Horowitz talks about Martin's experience at the FDA at a time when he was director of the Viral Oncology Branch at the FDA's Bureau of Biologics [now the Center for Biologics, Evaluation and Research] and that he had been informed that there was contamination by simian cytomegalovirus. This is important because Dr Martin has been reporting cases of a stealth virus—a CMV virus, which is in the herpes

"But you see, the Food and Drug Administration must turn a blind eye to at least 100 of these contaminants per dose because their hands are tied by proprietary laws and non-disclosure agreements placed upon them by the pharmaceutical industry."



family—in the Mohave Valley area in Arizona, which has been spreading in every direction and toward the major cities and population centres. I would like it very much if you would comment on this.

Dr Horowitz: Sure, Dr Mazlen, I'd be happy to. Now this basically comes from personal conversations with Dr Martin. Dr Martin, of course, as you mentioned, wrote the foreword to this book, *Emerging Viruses*, and he talks about his experience as the Bureau of Biologics vaccine tester and actually in charge of testing humans for vaccine contamination between 1976 and 1980. At one point in the book he cites the fact that there's no reason for these vaccines to continue to be contaminated, that the authorities hold the capacity and the technology to clean them up but yet they don't. Well, I go into detail about the social-political background on that, and I'm not going to go into that on your program today because we don't have the time, but let me give you one example.

When Dr Martin found some of these foreign viruses, DNA viruses and RNA viruses in the vaccines, he went to his superior at the FDA bureau and said to him: "You know, we've got a problem with these vaccines." And his boss said to him: "Stop worrying about it. Every time you eat an apple, you ingest foreign DNA." That was the response.

Dr Mazlen: That's not too comforting, overall. In fact, it's a comment that leads one to feel a certain sense of insecurity about vaccines, and there have been times when we've had guests on this program who commented about whether or not they should give vaccines to their children or to people with chronic fatigue syndrome. It makes it difficult to counsel them because you're really not sure what's there. Now specifically, Martin also mentions—and you say it in the book—that the SV40 which was in the oral polio vaccines is actually pretty much carried in the general community and it's spreading.

Dr Horowitz: Right, and as a matter of fact it was, I think, three weeks ago now when the *Journal of the American Medical Association* [JAMA] carried the first article showing that the simian virus 40, the 40th monkey virus ever discovered, was known in 1961 to be contaminating both Salk and Sabin polio vaccines and that, in fact, those vaccines had been given to well over 100 million people around the world, mostly in Russia.

According to Hilleman—we have him on tape, again being interviewed by Shorter—the joke of the day in 1961 became, since they had just inoculated mostly Russians with this contaminated vaccine, that the Russian athletes were going to come to the next Olympics full of tumours.

Well, you see, they never cleaned them up, not completely; and today, again, we're still getting and we're still giving contaminated monkey viruses to human beings.

The article in *JAMA* discusses specific types of cancers—"unique cancers", they said—and states that the general public should not be concerned. And I beg to differ with them. I think it should be an extreme concern. I think we should literally have a moratorium on US Government-promulgated vaccines until there

is a thorough, independent scientific investigation as well as, hopefully, a congressional investigation into all the documented facts. But the *JAMA* article said that there were now *unique* cancers associated with SV40.

An earlier article talked about 25 per cent of a very large Italian population carrying these monkey viruses in their bodies, and I suspect that it's a larger percentage here in the United States.

A woman by the name of Bernice Eddy [a doctor of bacteriology] discovered [in 1954, with cancer researcher Sarah Stewart] this particular virus that was first called SE polyoma. She discovered this virus in contaminated polio vaccines, and she took photographs of a dozen monkeys which had keeled over dead and paralysed when she administered the vaccine. Her boss at the NIH confiscated the photos and demoted and defunded her; and then 10 years of crusading later, in 1972, she gets before Congress and she tells the United States Congress people: "If you continue to allow these contaminated vaccines to go out, I guarantee you

that over the next 20 years you will have epidemics of cancer unlike the world has ever seen." And that's precisely what we have today.

Dr Mazlen: Certainly, if you include the AIDS virus as part of this, no doubt. In terms of your research—which is extensive in the book, and I certainly think that anyone who reads it will be impressed by the amount of work you've done—you do go into, at length, the fact that the AIDS virus might have come about through synthetic development, blending a number of killer viruses in an effort to make an immune-destroying virus. When did that happen?

Dr Horowitz: This type of research, wherein simian virus 40 and other monkey viruses were used and then mutated or hybridised with other animal cancer viruses, began in the early 1960s. The contracts that are reprinted in *Emerging Viruses* show that it was February 12, 1962 that the Special Virus Cancer Program began. That was a largely funded, mostly secret program that resulted after the people on the inside at the National Institutes of Health realised they had just inocu-

lated well over 100 million people around the world with cancer-virus-ridden vaccines.

When they started this, it was kind of like the ground floor of a huge business opportunity at that point, and they began to do extensive research in mutating monkey viruses to see what would produce cancer with them, and then, perhaps, how they might be treated with vaccines and whatever else.

So, it was in the '60s, and particularly by the late '60s, that researchers at Litton Bionetics—Dr Robert Gallo was overseeing them—and researchers at the National Cancer Institute as well, were very adept at taking monkey viruses and recombining them with things like feline leukaemia virus RNA that caused a whole laundry list of symptoms virtually identical to what AIDS patients suffer from. Another favourite one that they used to mutate monkey viruses with, was the chicken leukaemia sarcoma virus RNA that caused wasting, immunosuppression and death. And then the researchers recorded that to get this type of a virus to jump

"...Bernice Eddy [a doctor of bacteriology] discovered this virus in contaminated polio vaccines, and she took photographs of a dozen monkeys which had keeled over dead and paralysed when she administered the vaccine. Her boss at the NIH confiscated the photos and demoted and defunded her..."

species readily—they cultured it in human white blood cells in some studies and human foetal tissue cells in culture in other studies so that it would adapt—the virus would develop what's called the "attachment apparatus". Those are the unique proteins like the gp120-like protein.

Dr Mazlen: A couple of very important things I want to say before we have to close the show for today. One, is it safe for people to donate blood if you're not screening for SV40 and simian CMV virus?

Dr Horowitz: No, I think not. I think that's a very urgent question that should also be addressed by independent scientific investigation and congressional investigation. You see, the blood bankers—the international blood "banksters", as I like to call them—are the people who allowed 10,000 haemophiliacs throughout the United States to get HIV-contaminated blood. And recently we've been told that if you had a blood transfusion between 1970 and 1990, you'd better go get checked for the cancer ticking-time-bomb virus called hepatitis C. These are the same people who have allowed these types of things. They're very related financially and otherwise to the companies that have been producing the contaminated vaccines. And my concern is that they're making vast fortunes off humanity's suffering through the healthcare system; and people are dying off on this planet. It's interesting that that fulfils a very clear and well-articulated, well-documented population reduction agenda. So I'm concerned about those issues.

Dr Mazlen: We're going to have you back at another time to talk about some of this. Because there's going to be a lot of people who are interested in your book and your research, what number can they reach you at about these things?

Dr Horowitz: Well, the materials can be gained by calling a toll-free number [in the USA]. It's 1888 508 4787. An easy way to remember that number is 1888-50-VIRUS. And I'm pleased to tell you that despite the fact that, over the last year and a half, all the major chain-store buyers have refused to buy the book—in other words, there has been a boycott against the book, *Emerging Viruses: AIDS and Ebola*—it did become a best seller in hard-cover about four months ago with the number of sales, but this week Crown Books finally gave us their first order. You could probably go get the book in Crown bookstores today.

Dr Mazlen: Congratulations on that. I want to ask you, though, are you researching now what's happening with some of these things? The hepatitis B vaccine you implicated might have been contaminated at one point in time. Is it still contaminated?

Dr Horowitz: Yes, it is. As a matter of fact, I came back from France not too long ago, where I met with one of the top virologists in the world—a cancer virologist who used to work with Gallo and Montagnier. His name is Merko Valjenski, and he basically gave me some scientific documents showing that today's hepatitis B vaccine is still carrying a very carcinogenic enzyme that the authorities have not yet removed.

Editor's Note:

Dr Leonard G. Horowitz's book, *Emerging Viruses: AIDS & Ebola—Nature, Accident or Intentional?* [ISBN 0-923550-12-7], was published in 1996 by Tetrahedron Publishing Group [20 Drumlin Road, Rockport, MA 01966, USA, phone (508) 546 6586, 1800 336 9266 (toll free, USA), fax (508) 546 9226, website, <http://www.tetrahedron.org/>]. The book was reviewed in NEXUS 4/01.

MAIGALOMANIA!

THE MULTILATERAL AGREEMENT ON INVESTMENT

If ratified, the Multilateral Agreement on Investment will place yet more power and wealth in the hands of transnational corporations, with questionable benefits to people worldwide.

Part 2

**A Briefing by
Corporate Europe Observatory
(CEO) © February 1998**

c/- Prinseneiland 329
1013 LP Amsterdam, The Netherlands
Telephone/Fax: +31 30 2364422
E-mail: ceo@xs4all.nl
Website: www.xs4all.nl/~ceo/

Third World countries revolted against the MIA [the Multilateral Investment Agreement within the World Trade Organization] from the beginning. In January 1996, for example, Malaysian Prime Minister Dr Mahathir Mohamad commented that his country was "aware of such moves and...will take steps to ensure that such an unfair trade treaty will not be pushed through".⁴⁶

Soon afterwards, eight Third World countries, including India and Indonesia, issued a statement declaring their "objection to the bringing up of the trade and investment issue in the World Trade Organization".⁴⁷ Couching their displeasure in diplomatic terms, these countries expressed their concern that an MIA would impact on "the ability of national governments to regulate FDI flows so as to support national development objectives and priorities". "Equally unclear", the eight governments stated, "is the nature of the potential benefits and costs of FDI and its relationship to the globalisation process and the accompanying phenomenon of marginalisation".⁴⁸ Instead, they demanded that the investment issue be discussed within the framework of the UN Conference on Trade and Development (UNCTAD) which lacks binding juridical powers and in which developing countries are at a less glaring disadvantage as in the WTO. These resistant Third World countries had learned a lesson from the Uruguay Round of the GATT: that the initiation of negotiations generates enormous pressure for the completion of far-reaching treaties.

Despite these clear signals from Third World governments, WTO Director-General Ruggiero nevertheless placed investment on the agenda for the WTO's December 1996 Ministerial Conference in Singapore. The EU and other proponents of the MIA had by that time adapted their proposal into a "study process" on the relations between trade and investment.⁴⁹

During the course of the Singapore conference, those countries who resisted bringing investment onto the WTO agenda were one after another prodded to change their position. Some countries lobbied with some success to limit the scope of the working group. The last country to give in was India, which ultimately joined the last-ditch efforts to prevent the proposed working group from preparing the elements of an MIA negotiation process.

In an utterly undemocratic procedure, a final draft declaration was negotiated by an informal group of 30 countries. It was presented to the conference plenary at the very last moment, accompanied by a plea from the chairman, Singapore's Yeo Cheow Tong, to countries to refrain from reopening discussions.⁵⁰ And so the WTO working group on trade and investment was born.

Following the Singapore conference, EU Commissioner Brittan envisioned the door to a multilateral "framework of binding rules" on investment wide open. He declared: "...on investment...we have at least put WTO on the map. Investment indeed seems to me to be the top priority for WTO in the years ahead."⁵¹

Third World negotiators, on the other hand, emphasised that they had managed to stop negotiations on an MIA from being launched. India's Commerce Secretary Tejendra Kanna said: "We made it clear that no mandate can be given for a study of an MIA. This is not permissible even with the two-year period. If it ever comes to that stage, even then we will block it."⁵²

INVESTMENT WORKING GROUP NEGOTIATIONS

The tension between OECD countries and MIA opponents was tangible at the three meetings of the working group in 1997, at which the OECD, UNCTAD, the World Bank, the IMF and other international institutions were observers. Whereas the EU has continued to urge for the commencement of negotiations, countries like Malaysia, India,

Indonesia and Pakistan remain outspoken against even the smallest steps towards a global investment treaty.⁵³

The working group has been discussing trade, investment, development and economic growth on an abstract level, but in 1998 will also take on "multilateral agreements and initiatives".⁵⁴ Its report to the WTO Ministerial Conference in May 1998 [as we go to press] is not likely to contain any controversial recommendations, and it is not expected that any decisions on investment will be taken at this meeting.

Over the [northern] summer and fall, however, debates in the working group will heat up in anticipation of the December 1998 deadline for the final report to the WTO General Council. Proponents of a WTO treaty on investment will attempt to rally support for the preparation of negotiations; their success largely hinges upon the fate of the MAI negotiations. Observers expect that the EU and others aim to revitalise MIA so that negotiations could begin by 1999 or the year 2000.

According to some sources, the most likely strategy is the initiation of a new general round of negotiations to include worldwide liberalisation of agriculture, investment and several other issues at the beginning of the new millennium.

WORLD TRADE ORGANIZATION

The World Trade Organization (WTO) came into being on 1 January 1995, following the signing of the GATT global free trade agreement in 1994. The WTO's mandate is to remove obstacles to trade, and governments can ask its dispute settlement body to investigate whether another country's legislation might in fact be a trade barrier. WTO decisions are binding and can be enforced through the implementation of trade sanctions against the disobedient government by all WTO member countries.

The most recent WTO judgement that a consumer protection law acted as a trade barrier concerns the European Union's ban on growth hormones in beef, but many more cases are on the way. Just as the US raises cases on behalf of its corporations, the EU questions US food safety and environmental legislation on behalf of Europe-based TNCs.

The US, the EU and Japan are continuously seeking the expansion of the WTO's mandate, as their industries crave access to the last remaining unprotected sectors of Third World economies. Since 1995, steps have been taken to liberalise telecommunications and financial services.

Despite fierce Third World opposition, a WTO investment liberalisation treaty is still a high priority for OECD countries and, in particular, for the European Union.

UNCTAD

The United Nations Conference on Trade And Development (UNCTAD) is increasingly used by OECD countries and business groupings as a forum for moving Third World countries in the direction of a friendlier position on investment deregulation.

The UNCTAD, at its May 1996 conference in Witrand, South Africa, received a mandate to study the development implications of existing investment arrangements, like bilateral investment treaties (BITs), and to discuss the necessity of a multilateral framework for investment.

At the conclusion of their June 1996 meeting in Lyon, France, G7 leaders described the results of the Witrand conference as "a major milestone in the renewal of UNCTAD" and applauded the refocusing of UNCTAD's work on "a small number of priorities to promote development through trade and investment, with the aim of facilitating the integration of developing countries in the international trade system".

Although consensus-building on investment rules within the UNCTAD is informal, developing countries didn't join without nudges from their industrialised neighbours. As EU Commissioner Sir Leon Brittan put it in a speech to a business audience in Cologne: "Informal discussions have already begun in Geneva, largely thanks to European and Canadian pressure. We have been trying not to bludgeon developing countries into submission, but to share with them the fruits of our latest analysis, in order to show that investment liberalisation is a winning strategy for all players."⁵⁵

And not only G7 governments are trying to lure developing countries into the UNCTAD massage parlour: major industry lobby groups like the European Round Table of Industrialists (ERT) and the International Chamber of Commerce (ICC) have also discovered the usefulness of this institution.

In December 1997, the ERT and the UNCTAD Secretariat co-organised a high-level meeting of 25 Geneva-based ambassadors from developing countries and some 16 CEOs of ERT companies to discuss a June 1997 ERT working paper on investment. This meeting was chaired by the UNCTAD Secretary-General, Rubens Ricupero, and ICC and ERT Chairman Helmut Maucher of Nestlé. Maria Livanos Cattai, Secretary-General of the ICC, was also present.

And at UNCTAD's 1996 World Investment Forum Conference, the ICC spoke on behalf of world business, outlining what Third World countries should do to attract foreign

direct investment. Asking investors to fulfil special obligations, for example, was strongly discouraged.⁵⁶

INTERNATIONAL MONETARY FUND

The International Monetary Fund (IMF), traditionally responsible for helping countries meet their balance-of-payments requirements and setting currency standards, has been a key instrument in prying open markets for foreign investors and bailing them out in the case of financial crisis. The IMF's crowbar is a set of investment liberalisation measures which rob countries of their economic sovereignty.

As James Tobin, the Nobel laureate economist who proposed a tax on all international currency transactions, put it: "It is hard to escape the conclusion that the countries' currency distress is serving as the opportunity for an unrelated agenda—including the obtaining of trade concessions for US corporations and expansion of investment possibilities."⁵⁷

And indeed, the recent IMF "recovery packages" for the shattered economies of South Korea, Thailand and Indonesia included a number of provisions that might have been taken straight from the text of the MAI. These included requirements that the indebted governments guarantee the following: the right for all foreign investors to establish investments in every sector of the economy; the weakening of labour and environmental standards to attract

The IMF's crowbar is a set of investment liberalisation measures which rob countries of their economic sovereignty.

investment; the removal of safeguards in stock markets that limit flash sell-offs and capital flight; and prevention against the adoption of regulations which would restrict or control foreign investment in their countries.

Today, with the Asian economies more exposed, TNCs are buying out local companies at bargain prices and, at the same time, gaining new market territory for themselves.

FUNDAMENTAL FLAWS OF THE MAI

The next few months will be decisive for the future of the MAI, the Multilateral Agreement on Investment. OECD negotiators appear determined not to extend the deadline for the negotiations a second time. They are racing against the clock to resolve conflicts between various countries, and are busily decorating the agreement with non-binding wording on social and environmental standards in an attempt to neutralise the critique and improve the chances of getting the MAI through national parliaments. Any further delay would leave MAI's future extremely uncertain. Experience has shown that additional time serves only to multiply problems for the negotiators, as more and more negative impacts of the MAI come to light.

Most recently, the European Parliament's queries about how the MAI would affect future possibilities for improving social and environmental policies within the EU have brought problems with the MAI to the surface.

The multiplying number of pages of reservations demanded by national delegations have placed the OECD's rosy picture of a 'win-win' treaty in a more realistic light. That the negotiating governments are at last becoming wary of the impacts that the MAI will have on their societies is a clear indication of the fundamentally flawed character of the treaty.

MAI negotiators are likely to announce a political agreement on the MAI at the OECD's Ministerial Conference in May. Over the next months they will focus on adding the finishing touches so that the treaty can be officially signed in November 1998. This is obviously a highly undemocratic procedure and is symptomatic of the entire process to date.

Although the rigid economic model that MAI signatory countries will be forced into may enjoy strong governmental support today, it will likely attract growing critique over coming years as its social, environmental and political impacts become increasingly visible. Joining the MAI involves a 20-year lock-in to a deregulated system in which countries are completely dependent upon the global economy, foreign investments and foreign investors—in other words, upon TNCs. Countries facing economic problems or other challenges will be barred from seeking new solutions. This is not only undemocratic but also extremely dangerous.

Citizens' campaigns against the MAI are increasing in strength day by day and in country after country, and the media are at last taking notice of the treaty. The NGO plot to kill the MAI has been termed "the Dracula strategy": simply, bringing public attention to a treaty that cannot stand up against the light.

Thus far, the response from OECD governments to the increasing pressure has been the addition of non-binding language to the treaty's preamble and elsewhere, but most NGOs recognise these as pseudo-solutions that do not change the fundamentally flawed character of the MAI.

DANGERS OF TNC DEPENDENCY

The OECD's haste in pushing the MAI through can also be attributed to the fear that the deregulation wave may be losing momentum. MAI negotiations started in 1995 at a time when OECD countries were intoxicated by the signing of the GATT and the birth of the WTO. Since then, although many more steps have been taken on the path towards a deregulated world market without borders for goods or capital flows, there are also increasing signs of a backlash arising from Southern governments and from people all over the world.

The financial crisis in Asia was a painful lesson for the many Third World countries which had been forced to scrap the very regulations that could have prevented such a crash. Some governments, including Thailand, have now started talking about the need to reintroduce regulation.

Critique of the deregulation model has also recently come from surprising corners: financial speculators George Soros and the late Sir James Goldsmith, for example, have both repeatedly warned against the social and environmental dangers of unbridled economic globalisation.

The next step includes voicing clearer alternatives, and advocating policies which reduce the current dangerous dependency upon transnational investment. Economic globalisation and deregulation have created a vicious circle in which investment dependency forces workers, communities and governments into increasingly harsh competition on wages, taxes, environmental protection and anything else that might influence investment conditions.

That international competitiveness is becoming the single most important factor determining the health of a society is a scenario for disaster and will unavoidably lead to a downwards spiral in social and environmental standards, and delay or freeze desperately needed progress in these areas.

It is in reaction to this economic dependency upon TNCs that OECD governments have developed the MAI in close cooperation with business lobby groups, and why they are now desperately trying to push it through before the public is clued in to what is happening.

Finally, TNC dependency is what is stimulating an increasing number of Third World countries to queue up to sign the MAI so that they can receive a stamp of approval for having a first-class investment climate.

There are no lack of policy options for reducing TNC dependency and putting economic diversity and prosperity of local communities first. These options include: community reinvestment rules; limits on company size to avoid unfair competition; subsidies for local production for local use; efficient taxation of TNC profits to ensure that the local economy benefits from their presence; regulation of capital flows; and numerous other currently unfashionable policy options. Of course, these are the type of measures which would be banned if the MAI survives.

MAI entails the institutionalisation of neoliberalism as the only option—the creation of a global economic constitution that is the equivalent of economic monoculture.

The struggle against the MAI has demonstrated the enormous necessity and potential for grassroots globalisation on these complex, far-reaching issues. Information and strategies are being shared among an increasingly strong network of citizens, NGOs,

The NGO plot to kill the MAI has been termed "the Dracula strategy": simply, bringing public attention to a treaty that cannot stand up against the light.

workers, development organisations, women's movements and church groups. Although effective resistance to the MAI has arisen late for a variety of reasons, there is no doubt that NGOs are now catching up. With an increasingly clear, common analysis of the dangers of corporate-led globalisation, civil society is getting prepared to defend our local economies, our democratic systems and the common good.

THE MAIN CORPORATE PLAYERS:

The preceding parts have given ample examples of how corporate lobby groups have been involved in the shaping of the MAI. The following is a more detailed overview of the main corporate groupings and the manifold strategies they have used in their crusade for investment deregulation in various international forums.

INTERNATIONAL CHAMBER OF COMMERCE

One of the most heavyweight corporate players behind the MAI is without doubt the International Chamber of Commerce (ICC). The ICC, which promotes itself as "the world business organization" with members in over 130 countries, is not primarily an umbrella for chambers of commerce from around the world, as the name might suggest.⁵⁸ Its membership includes some of the world's wealthiest transnational corporations: Asea Brown Boveri, Bayer, British Petroleum, Dow Chemical, General Motors, Hyundai, Nestlé, Novartis, Shell, Toshiba, Zeneca and so forth. Quite a few national business associations are also part of the ICC.

The ICC, which clearly has ambitions to become a major player in global politics, shares its chairman, Nestlé president Helmut Maucher, with the influential European Round Table of Industrialists. The ICC's Secretary-General is Maria Livanos Cattai, who, over a period of nearly two decades, developed the World Economic Forum and its annual meeting in Davos, Switzerland, into a hugely influential global summit of corporate leaders and top politicians.

ICC involvement in the MAI negotiations has partly been through the Business and Industry Advisory Council (BIAC), the official business delegation to the OECD negotiations.

The Chamber itself has left a number of fingerprints on the draft treaty—for instance, regarding arbitration. In the current draft, the ICC's Court of Arbitration is included as one of the main mechanisms for dispute settlement. Vincent J. O'Brien of the ICC said: "We definitely helped with the parts regarding arbitration. The ICC clearly has expertise in that area, and so it was natural that we had a hand in there."⁵⁹ One of the most controversial aspects of the MAI—the investor-state dispute mechanism which will allow corporations to sue governments in an international court—has been developed with the assistance of ICC 'experts'. The role of the ICC in this mechanism will be to oversee disputes and facilitate the settlement process.

The MAI allows its signatories to declare certain laws exempt from the treaty for national security reasons. However, it is up to the MAI dispute settlement panel—overseen by the ICC—to determine whether such a claim is valid. No one is entirely sure how the MAI would affect national law, as interpretation of the treaty will be left to an independent panel appointed by defendants and corporations bringing the dispute. Under the proposed

MAI, state courts will have no jurisdiction in this area of law.

The ICC has also made use of its access and consultative status at major international summits to push for the MAI. During the Denver, USA, Summit of the G7 in 1997, the ICC met with the heads of state of the Group of Seven most industrialised countries and presented its viewpoints. Among other things, the ICC urged the leaders to work harder to ensure that the MAI negotiations are concluded quickly and that there be a complete rejection of environmental and labour standards.⁶⁰

The OECD treaty on investment is a major goal for the ICC, but it is only the first step. In the spring of 1996, the ICC published its report, "Multilateral Rules for Investment",⁶¹ in which it expressed its support for all of the major elements in the MAI: the broad definition of investment, national treatment, most-favoured nation treatment, investment protection, and binding investor-state arbitration. The report strongly supports the MAI negotiations, but ends by calling for the December 1996 WTO Ministerial Conference to "begin within the WTO to establish a comprehensive and truly global framework of rules and disciplines to govern cross-border direct investment".⁶²

EUROPEAN INDUSTRY AND THE MAI:

The two most influential European corporate lobby groups—the European Round Table of Industrialists (ERT) and the Union of Industrial and Employers Confederations of Europe (UNICE)—have followed different strategies in their striving for an international investment treaty.

EUROPEAN ROUND TABLE OF INDUSTRIALISTS

The European Round Table of Industrialists (ERT)⁶³ has long been deeply involved in the push for investment liberalisation, and has built a very comprehensive strategy to this end. While supporting the MAI, its main objective is an investment

One of the most heavyweight corporate players behind the MAI is without doubt the International Chamber of Commerce (ICC). Its membership includes some of the world's wealthiest transnational corporations.

agreement at the WTO.⁶⁴

As early as its 1993 report, "European Industry: A Partner for the Developing World", the ERT had stressed the need for "a GATT for investment" and "an institution that could take stock of improvements and be able to lock-in the process of liberalisation".⁶⁵ This point has been often repeated in the five reports on investment produced by the ERT North-South working group since 1993. ERT president Helmut Maucher, who also heads the ICC and is the CEO of Nestlé, chairs this working group.

The ERT has long played an active role in setting the EU policy agenda. In making the case for investment deregulation, Round Table members are in direct contact with European leaders and the European Commission as well as Third World governments.

The Round Table is jubilant about the positive effects achieved by two of its proposed tools to further economic globalisation: competition on rules (the race to provide companies with the most favourable investment conditions) and benchmarking (encouraging countries to compare their investment climate, including levels of deregulation). "Competition on rules and benchmarking have proven to be among the most effective drivers of the present process of opening the economy, deregulating and modernising the institutions for private business investments."⁶⁶

These concepts, presented in a 1993 survey on investment,⁶⁷

have been eagerly adopted by decision makers. "In the developing world it positively influenced attitudes and policies...it may have had an impact on the views and policies of the European Commission and European governments in external economic relations in many different ways."⁶⁸

The ERT advocates an investment agreement within the WTO which would include the main elements of the MAI but would extend even further. According to the Round Table, a WTO treaty should ensure "continuous opening, also on the sub-federal level" through "rules and criteria for efficient public policy benchmarking and institutionalised peer review".⁶⁹ The WTO treaty should be flexible in order to "extend the coverage of the framework to additional relevant areas". The ERT's dream treaty would also include international competition policy "able to address structural impediments" to market access which foreign investors might come across, "defining the relevant market as more and as global".

The ERT seems overly optimistic about the time frame for the completion of the WTO agreement they desire, proposing a "structured debate on strategy and concepts for a global agreement on investment at the next WTO Ministerial expected in June 1998", and the "rapid conclusion of an agreement of the new kind".⁷⁰ No doubt they will receive full support from the European Commission, one of the main advocates of an MIA within the WTO.

Trade Commissioner Sir Leon Brittan, in reaction to the 1996 ERT survey on conditions for foreign investment, said: "I was particularly struck by the message that we needed to think about the best role of international negotiation, and to strike a balance between using the WTO to establish agreed best practice and using the WTO process to create more modern and dynamic instruments such as public policy benchmarking. My own hope is that WTO can do both."⁷¹

The ERT has strategically facilitated the softening of developing-country opposition to a WTO investment agreement. Many Third World countries have argued that discussion on investment should be held within the framework of UNCTAD, so at the end of 1997 the ERT co-organised with this organisation a meeting on investment. In attendance were 16 CEOs from ERT member companies (including ABB, British Petroleum, Krupp, Nestlé and Shell), ICC Secretary-General Maria Livanos Cattau, and 25 Geneva-based ambassadors. The meeting focused on "dialogue on matters concerning FDI and the development dimension of the issues and concepts relevant to a possible multilateral framework on investment", and used the June 1997 ERT investment report as a basis for discussions.⁷²

UNICE

UNICE, the European industrial employers organisation, tends to play a more reactive role than the ERT, generally responding to specific European Union policies as they emerge.

As the EU has not officially released its position on the MAI, UNICE has thus far taken a back seat in the negotiations. Nonetheless, the group strongly supports the MAI and is represented in the negotiations through its BIAC membership.⁷³ Additionally, UNICE is a strong proponent of a Multilateral Agreement on Investment (MIA) within the WTO.⁷⁴

NON-EUROPEAN CORPORATE LOBBIES AND THE MAI: US COUNCIL FOR INTERNATIONAL BUSINESS

When it comes to lobbying for the MAI, one of the most influential industry groups has proven to be the US Council for International Business (USCIB). Founded in 1945 "to promote an open system of world trade, investment and finance",⁷⁵ it counts over 300 corporations, industry lobby groups, law firms and banks among its membership—including the American Petroleum Institute, BP America, Coca-Cola, Chevron, DuPont, General Electric, General Motors, the Global Climate Coalition, Honeywell, Ford, McDonalds, Mobil, Monsanto, Nestlé USA, Philip Morris, Shell, Texaco and Unilever.

The USCIB is the US affiliate of the ICC and the International Organization of Employers (IOE), and, most significantly, chairs the expert group of the OECD's Business and Industry Advisory Committee (BIAC).

One hundred and fifty CEOs are busy pushing for investment liberalisation through the USCIB's Investment Committee, chaired by Glen Skovholt of the Honeywell corporation.⁷⁶ This policy committee has been very active on the MAI and has used its widespread corporate tentacles for various pressure tactics.

In addition to regular meetings with US negotiators immediately before and after each MAI negotiating session, USCIB also arranges direct access for its members to Ambassador Frans Engering, chairman of the OECD MAI negotiating group.

Domestic support for MAI has been created by the USCIB's collaboration with groups such as the National Governors Association and the Council of State Government.

The USCIB's interest in investment liberalisation initiatives is not restricted to the MAI in the OECD. Facilitated by its membership in bodies like the Business Advisory Council for APEC (the Asia-Pacific Economic Cooperation forum) and the Trans-Atlantic Business Dialogue

(TABD), where it co-chairs the working group on investment, the USCIB ensures that investment remains at the top of the agenda in all relevant forums, including the WTO and regional treaties.

Overseas pressure is also a tactic, and a USCIB delegation visited the Japanese business organisation Keidanren in Kyoto in order to enlist support for US business objectives in the MAI.⁷⁷

There is no doubt that the USCIB has influenced the MAI from the beginning of the process. In 1991, four years before official negotiations began and long before MAI was out in the open, the USCIB was already providing input on pre-negotiation work. Later, in March 1995, the Council released a statement clarifying US business objectives, which, in its own words, "formed the basis of the formal BIAC submission to the OECD".⁷⁸

The USCIB is clear about why it desires a MAI treaty. "The MAI should eliminate many of the restrictions which make it too costly for US firms to access foreign markets", according to Stephen Canner, the USCIB's Vice-President for Investment Policy.⁷⁹ Consequently, the USCIB agrees with other industry groups that the inclusion of labour and environmental provisions in the MAI would be an enormous blunder, and has encouraged the US administration to resist pressure from these interests.⁸⁰ Such provisions, it believes, "will deter key LDCs [less-developed countries], who are not members of the OECD, from adhering, [and] thereby undercut a major objective of the United States—to

When it comes to lobbying for the MAI, one of the most influential industry groups has proven to be the US Council for International Business (USCIB).

have a number of key non-OECD member countries join the MAI before beginning negotiations on investment in the WTO".⁸¹

Recently the USCIB has shifted its focus to ensure that any reference to labour and environment in the MAI remain non-binding, threatening to withdraw its support for the MAI if this line is crossed.⁸² The trio of provisions (the so-called "three-anchor approach") that the group could swallow coincides with the environmental provisions presented by the US. These are a non-binding preambular statement on sustainable development, a non-binding provision on not lowering standards to attract foreign investment, and a non-binding attachment to the OECD's 1974 "Guidelines for Multinational Enterprises".

The USCIB also invested some energy in damage control after NGO campaigning in the US had stirred up some serious public doubts about the MAI. In December 1997, the USCIB published a letter in the *Washington Times*,⁸³ trying to calm fears about the MAI. The letter mocks the concerns of MAI critics, sarcastically asking: "Will the MAI allow big, bad multinational corporations to trample the rights of poor countries, undermine existing national environmental legislation and take away from US states their constitutional rights? Let's look at the facts..."—and referring to "the feverish atmosphere of Internet chat rooms".⁸⁴ The bottom line, the groups argues, is that investment is not bad for the environment, and that it will benefit "the United States in general...making the economic pie grow both here and abroad".⁸⁵

BUSINESS COUNCIL ON NATIONAL ISSUES

Founded in 1976 by the CEOs of US-based Imperial Oil and Noranda, the Business Council on National Issues (BCNI) is Canada's version of the European and US business round-tables. Among its 30 members are the CEOs of several large banks and major Canadian and foreign companies, including Air Canada, AT&T, Bechtel, Bombardier, Canadian Pacific, Cargill, DuPont, General Motors, Hewlett-Packard, Loram, MacMillan Bloedel, Mitsubishi, Monsanto, Nestlé, Northern Telecom, Petro Canada and Placer Dome.

Over the past two decades, the BCNI's relationship with successive Canadian governments has become increasingly intimate. The lobby group worked strenuously for the passage of the 1988 Canada-US Free Trade Agreement⁸⁶ and organised a costly campaign to secure the election of the current neoliberal government.

However, the BCNI's approach to the MAI has been less aggressive, perhaps due to the group's wish to sweeten its negative public image. At the November 1997 MAI hearings, the BCNI professed its strong support for the Paris negotiations, focusing on the people-pleasing, job-creation aspects that such a treaty would bring: "...recent studies have indicated that for each billion dollars invested over a five-year period in Canada, something in the order of 45,000 jobs are created."⁸⁷

BCNI companies have also used other forums to fight for their favourite provisions in the MAI. Lobbying has been conducted through the Canadian Chamber of Commerce and the Canadian Council for International Business, and the BCNI is also a member of the OECD's official business advisory council, BIAC. In particular, the BCNI is strongly opposed to the EU's general exception for regional economic integration agreements (which

would permit EU member states to discriminate against non-members), and, in solidarity with the USCIB, was quite disappointed at the recent rejection by US Congress of 'fast track' negotiating privileges for the President.⁸⁸

KEIDANREN

Keidanren, the most representative Japanese business coalition with over 1,000 members (including Toyota, Mitsubishi, Nissan, Sony, Sakura Bank and Nippon Steel Corporation), has also been actively pushing for the MAI. As Japan and South Korea are the only Asian OECD members, Keidanren's main goal is to sign as many developing countries as possible onto the MAI. Thus, while urging that the MAI remain a high-standard agreement, it recommends flexibility to facilitate the membership of non-OECD countries.

In addition, Keidanren has joined forces with UNICE to encourage the creation of a multilateral framework on investment at the WTO,⁸⁹ and simultaneously urges investment liberalisation through bilateral and regional agreements such as APEC.

Although generally pleased with MAI developments, Keidanren is disappointed that two of its main objectives—taxation and key personnel (which allows special privileges for corporate staff)—have been carved out of the agreement.

The Japanese lobby group is also trying to reduce general exemptions to the bare minimum—for instance, strongly opposing regional economic integration organisation (REIO) clauses (such as the one proposed for EU members), and rejecting extraterritoriality (such as the US Helms-Burton Act that punishes corporations active in Cuba), yet preferring that all sub-national levels of governments be fully bound by the MAI.

Though less aggressively than its US partners, Keidanren worries that additional labour and environmental regulations would prevent non-OECD members from signing on to the MAI.⁹⁰

Keidanren, the most representative Japanese business coalition with over 1,000 members (including Toyota, Mitsubishi, Nissan, Sony, Sakura Bank and Nippon Steel Corporation), has also been actively pushing for the MAI.

WORLD BUSINESS COUNCIL FOR SUSTAINABLE DEVELOPMENT

The World Business Council for Sustainable Development (WBCSD) has only recently stepped up its involvement in the MAI. Masquerading behind its carefully cultivated image as a 'green' industry lobby group,⁹¹ the WBCSD has been tremendously successful in promoting global market liberalisation and self-regulation by business instead of government intervention as the recipe for sustainable development. The WBCSD approach has left its mark on, for instance, the 1992 Rio Declaration and the climate treaty which emerged from Kyoto in December 1997. It is not surprising that the WBCSD has come out strongly in favour of the MAI, despite acknowledging potential problems.

The 15 January 1998 BIAC consultation was the first time that the Business Council's Secretariat had participated in official consultations on the MAI. In general, the group's involvement has been on the informal level. WBCSD president Björn Stigson has attended various BIAC meetings and is a member of its environment committee. Several WBCSD member companies are represented in BIAC, and the secretariats of both organisations interact

Continued on page 85

Dr Sam Chachoua's INDUCED REMISSION THERAPY

**Dr Sam Chachoua
has identified
'nemesis organisms'
that can control and
even cure diseases
such as cancer and
AIDS, but his
therapies have been
largely ignored by
the medical
establishment.**

Part 2

From a lecture presented by
Sam Chachoua, MB, BS
on "Revolutionary New Therapies in
the Treatment of Incurable Diseases"
at the 2nd World Congress on Cancer
Sydney, Australia
15-19 September 1995

We published the first part of Dr Sam Chachoua's story in NEXUS 5/01 and promised to follow up with further detail on his Induced Remission Therapy. Here we present an edited transcript of the lecture he gave at the 2nd World Congress on Cancer, held in September 1995, followed by a recent update from Dr Chachoua. — Editor

My name is Sam Chachoua and I'm an MD from Melbourne, Australia. What I'm going to talk to you about now is something quite new and revolutionary. It's called Induced Remission Therapy and it's a treatment that is based on three natural phenomena: organ resistance, organism resistance, and spontaneous remission.

I first got into cancer research at an early age when my father was diagnosed with multiple myeloma, and I basically tried to see whether I could find something that could help him where conventional therapies were failing. One thing that I noted in all the studies I had was that there are parts of the human body—for example, the small intestine—which are consistently resistant to cancer. Regardless of how far and wide cancer usually spreads, it usually leaves the small intestine alone.

There's also something known as "organism resistance", which means that most other animals that we try to give human cancer to are able to reject it. So I set about designing an experimental protocol where I was going to find out what it was about the small intestine that made it resistant to cancer, and I was going to find out what it was about horses, cats and dogs and other animals that made them resistant to human cancer.

To cut a long story short, I managed to isolate the immunological factors which I used in experimental protocols at the Peter McCallum Cancer Institute. At age 18 I'd written my first paper, and the following year I presented it before the Clinical Oncology Society of Australia. Let me tell you, I was pretty proud of myself. I thought: "Kid, you've got it made; you've helped your dad now, and this therapy is going to be adopted soon." And I could just see it. I was going to walk into the Clinical Oncology Society of Australia. Everybody's going to cheer and get on the phone and say: "Hey, we've got a young kid here; give me the Nobel Committee." Naive! I was actually greeted with all the warmth one usually reserves for a venereal disease or an acute attack of haemorrhoids!

Let me just jump to how this form of therapy can apply to AIDS. We've known for a very long time that it's impossible to give animals AIDS by injecting them with HIV. Now there are two possibilities: either animals are inherently resistant, i.e., they don't have receptor sites for HIV; or maybe, just maybe, they have an immune system which is capable of fighting and destroying the virus. Well, hey, let's check it out!

So the initial data all showed promise that you could raise an immune response out of a horse, for example, that would selectively destroy HIV. What intrigued and amazed me was seeing the thought processes or, rather, *not* being able to see the thought processes in the AIDS researchers who for years now have tried to find some way of developing an immune system resistant to AIDS. They sit there and say: "Well, we need to make an animal model. Once we have an animal model, once we've made an animal sick with AIDS we can find a way to cure it." So they get their little test animals; they get their rats, their dogs, their horses and cats; they inject them with HIV—and they can't give them AIDS! They get really upset about that: "How am I supposed to find a cure for AIDS if I can't give this animal AIDS? I'm injecting it with HIV to try to find an immune response that will kill HIV, and it won't take it. How am I supposed to do my job?" Are you following the thought pattern here? It's looking right at them.

It would seem a bit of an anticlimax if I were to tell you that one of the easiest ways to deal with the greatest plague today is to use an animal system that's resistant to the plague, and treat and cure the people suffering from the disease. A hundred years ago, before we had antibiotics, the only therapy we had for pneumonia, smallpox and polio was horse serum. They'd get a horse, shoot it with a disease, draw the horse serum out, shoot that into the person and cure them. If that therapy was good enough to deal with the plagues a hundred years ago, why isn't it being applied now?

But what happens if you do apply it now? Here's the case of a young man with AIDS. He's 32 years old. He's got a pneumocystis pneumonia, he's short of breath, he's got a T-cell count of 80 and a T4/T8 imbalance. So, essentially, his blood, his virus, is extracted out; an animal, such as a horse, is vaccinated with his blood; the antiserum from the animal is then purified against this patient's blood so it doesn't cause allergic reactions; and the patient is treated with the horse's serum. And we see that within 24 hours, the pneumocystis pneumonia clears up. That's pretty remarkable considering that the best that antibiotics can do, if they can clear it, is take days to weeks. This patient's symptoms resolved; his T-cell count went up to 780 within 10 days from a low of 80, and his T4/T8 ratio became normal.

Now what I've just told you is pretty dramatic, but doesn't it make some sense to you? Isn't it common sense? We have a disease that can ravage our immune systems but can't ravage a horse's, can't ravage another animal's. Why not use those animals' immune systems to destroy the disease?

So, off I went to the big hospitals in the US, and I said, "Hey, guys, look at this!" I showed them the case study and the patient I brought with me. I showed them 'befores' and 'afters' which were done on US soil, and they said: "Inject a person with horse serum? Are you insane? We'd never do that."

A few months later, some of the people whom I was speaking to from a related centre—friends of theirs, actually—came out with the

announcement that they're going to give a baboon's bone marrow to an AIDS patient because baboons are resistant to HIV!

At that stage, feeling dejected and rather silly, I set about trying to investigate as much in the way of alternative therapy and conventional therapy as I could—and believe me, I investigated just about everything, down to laughter therapy!

Now one thing that really struck me very quickly on in the piece when I was reviewing all the alternative, natural and conventional therapies is that there are two misnomers that exist in this world. One of them is "natural therapy".

Please, don't take me the wrong way. There's a lot of good in alternative therapy, there's a lot of good in vitamins and diet, but what on Earth is natural about shoving 50,000 units of vitamin C intravenously? What's natural about injecting ozone into

somebody's backside? What's natural about cappuccino enemas?

The other great misnomer in the medical field of conventional therapy are the terms "radiotherapy" and "chemotherapy". How the world "chemo" ever got side by side with the word "therapy" is beyond me. Never before has a therapy repeatedly failed for 80 years, caused the most hideous side effects known to man, and continued to prosper and flourish. It amazes me that chemotherapy has spread its wings without people knowing.

For example, how many people know that the commonest therapy for aggressive psoriasis these days is chemotherapy? Teenagers and people of child-bearing age will go to the doctor, and their doctor will say: "I'll give you a folic acid antagonist called Methotrexate." You see, "folic acid antagonist" sounds better than "chemotherapy", doesn't it, but it's chemo. These kids are swallowing poison, and they and their kids will suffer the consequences.

Did you hear about the latest breakthrough, a new form of contraception that's now on the market? It's a one-shot abortion injection. Well, the abortion injection is a folic acid antagonist. It's chemotherapy.

We have a disease that can ravage our immune systems but can't ravage a horse's, can't ravage another animal's. Why not use those animals' immune systems to destroy the disease?



Fig. 1a: Breast cancer seen on mammogram of 65-year-old female.

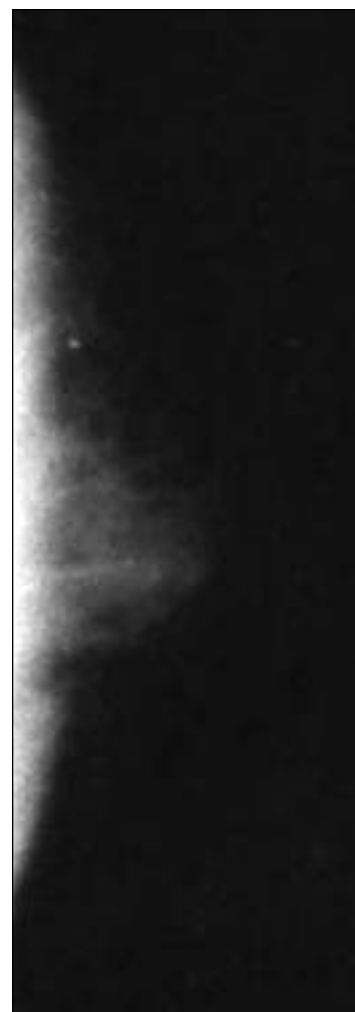

Fig. 1b: After 10 days of treatment, breast is back to normal.



Fig. 2a: Non-Hodgkin's lymphoma seen in 32-year-old-female.

Let's be blunt about something. Alternative therapy is great, and we can probably extend and improve the quality of life of people who are ill, and, heaven knows, we can prevent a lot of diseases from happening; but when you cut down to the chase, conventional therapy and alternative therapy are joined by one thing.

Over the past hundred years in the war against cancer, we've failed abysmally. Let's be frank here: if a hundred people were to do the most arduous alternative therapy available, we would not cure a hundred cancer patients; we would not cure a hundred AIDS patients.

There are only three reasons why we're failing in our war. One possibility is that the weaponry isn't powerful enough. Now, in chemotherapy and radiotherapy we have weaponry that can cremate a person! So, it can't be that one; rule that one out. The second possibility is that the target is invisible. Now we know that to be true; we know that cancer cells are immunologically invisible. The third possibility is that there's another target.

The one thing I found depressing about alternative and conventional therapy is that they both totally ignored the phenomenon of "spontaneous remission" which is perhaps the most natural phenomenon which repeatedly tells us how to cure terminal disease. "Spontaneous remission" is a term given to miraculous healings, where people on their death bed 'rise from the dead' within two to three days without a trace of their disease. It's a phenomenon that's been reported in the literature but hardly ever investigated.

The data on spontaneous remission strongly suggest that just before a person with cancer, heart disease, arthritis or any of the other terminal diseases has a spontaneous remission or a cure of their disease, they suffer what seems to be a viral or bacterial or some form of severe infection.

This was noticed by a Dr Didot, in France, who noted that the existence of syphilis precluded the appearance of cancer. If prostitutes had syphilis, they were very unlikely to develop cancer. This doctor actually treated 20 cancer patients with syphilis and, of those 20, 14 went into total remission. As the syphilis grew, it munched up the cancer; the cancer went away. Another three patients did pretty well, and a couple of them died of the syphilis. But this was a few hundred years ago, and given the choice between "the Big C" and "the Big S"—well, today we can cure syphilis with a couple of shots of penicillin, or so I've been told!

Late last century, Dr William Coley had a patient who had bone cancer and developed a severe syphilis or skin infection. As the skin infection grew, it munched on the bone cancer and the bone cancer disappeared. Dr Coley went on to develop what he called "Coley's toxins" and used them for many years as a therapy that got quite good results.

The trouble here is that Dr Coley succumbed to what I call "macho medicine". The infection he isolated from the patient, and which cured the patient, had remarkable successes in subsequent patients treated with the same infection, but he wasn't happy with that. Coley wanted something that would do better, so he found a more toxic infection. Instead of using the specific *Streptococcus* strain which he'd isolated from the patient, he found a *Streptococcus* that kills people, reasoning that it's more toxic, therefore it will kill more cancer, and therefore the chances of cure are better.

It's been long known that in areas where malaria exists, there's no cancer; and when you get rid of malaria, drain the swamps, kill the mosquitoes, the cancer rate rises. People who have cancer and who catch malaria have a chance of going into remission. Just recently, Dr Henry Heimlich [who developed the Heimlich manoeuvre for preventing choking] injected a few AIDS patients with malaria and managed to get them into some form of remission where they improved and stayed stable at the improved level.

All these observations led me to come up with something I call "nemesism theory", which states that for every disease there's an antidisease organism which will specifically attack and destroy it.

This then led to the development of "nemesism therapy", where I make extracts of these "nemesism organisms" with which to treat specific diseases.

And how do you find nemesism organisms? Well, you look around. Where there's a disease and there's less of another disease, the chances are that they're antagonistic to each other. Or, you work on basic levels, as I like to do, and do test after test after test to check.

What I did in the laboratory was get thousands of bottles and place leukaemia lymph node tumour biopsies in them. Each bottle had a particular organism growing inside it. The one with affinity for the cancer actually grabbed hold of the cancer and ate

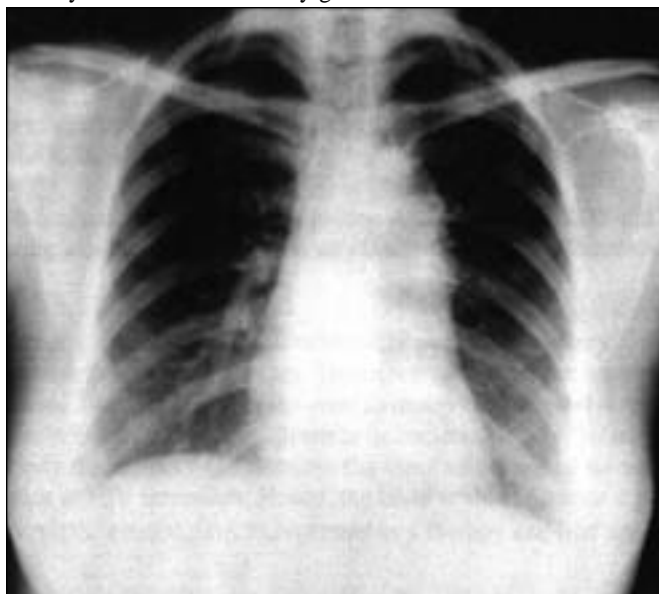

Fig. 2b: Resolution of lymphoma after two weeks of treatment.

it. This protein 'web'—actually, a fungus—shot up and encapsulated the tumour. Within a few days, there was a little bit of the cancer left. A couple of weeks later, no cancer—just the fungus!

So what this does is it gives us this new therapeutic modality. This nemesis organism can now give us highly specific chemicals that it used to kill the cancer, but which can be made so they do not attack any other sort of tissue. Two, it can give us tagging complexes which stick to the outside of the cancer and make the cancer highly visible to the immune system. And three, it can give us a complete range of digestive enzymes which are specific for digesting the cancer and the cancer alone. So this little baby not just kills the disease, it also cleans up after itself!

With use of the tagging system, if the immune system looks at this fibrillary network of protein stuck onto the outside of the cancer, it doesn't see cancer; it sees a bug and it wants to go after the bug. Now, you don't inject the bug; you purify the protein extract that sticks to the cancer and you inject that. That then sticks to the cancer in the body. The body can then see it and recognise it because it's tagged with bacterial, fungal or viral protein.

You and I have no trouble getting rid of a cough or a cold in a week or two. We can get rid of cancer: make the cancer *look* like a cough or a cold by sticking cough or cold particles on it, and the body will attack it, destroy it and remove it.

However, there were instances where patients had a regression several months or years after treatment of their tumours with a tagging complex. This suggested that tagging the cancer was not the be-all and end-all, that tagging the cancer cell still didn't cure cancer the disease. There was another factor at work.

An interesting observation was made about 20 years ago when leukaemia patients were treated by wiping out their bone marrow and then giving them somebody else's bone marrow. It was found that the leukaemia would invariably recur. And you know how they say how cancer comes back? Well, the doctor says: "Sorry, Mr Jones; it seems that when I was operating on you and I was giving you the chemo and the radio, one cell spilt, and this one cell hid

and then went all over the place and grew again—just this one cell, the spilt cell." One cell or a few cells get loose and the disease comes back. This may account for some of the cancer recurrences, but to try to explain *all* cancer recurrences that way, the medical term for that is "crap"!

What we know from those leukaemia trials is that they wiped out the patient's bone marrow. There was nothing left! They gave him someone else's bone marrow. Six months later, the leukaemia came back. Now, if it was a leftover cell, then when you check that leukaemia cell you should find that it's the same as the leukaemia you treated before the patient went into remission, true? It should be the same cell come back. However, when they ran DNA checks, they found that not only wasn't it the same cell, but it belonged to the donor. It was the donor's bone marrow that had turned into leukaemia cells!

This finding has been published in the conventional medical literature, and it means that cancer the disease is not cancer the cell. There is something in the body of a patient which regenerates and augments cancer, the cancer cell. And if you don't address that, then you won't get rid of the disease.

So there I was, with all these little bottles, cooking up these nemesis organisms and tagging them, but something kept showing up over and over and over again which was driving me nuts. I would incubate the cancer with another organism—say, an *E. coli*—and I'd find other organisms growing when the cancer cells died, that I hadn't put in there. They would usually be staphylococcal or streptococcal in appearance. Acid-fast bacilli sometimes would show up, depending on what culture medium was used and for how long I cultured them.

Now this is really interesting. What you notice is what some people would call "pleomorphism" in progress. A couple of elements would develop these elongated rodlike structures, and you could actually see a coccal form changing into a rodlike form. Pleomorphism in action.

I went to my colleagues and said: "Look, why do I keep getting these bugs? It's a sterile cancer I'm putting into the bottle, for goodness sake. I'm incubating with something completely different, and these bugs keep showing up." And they said: "Well, Sam, you know what you're like. You probably sneezed and contaminated the whole lot!" Then I said: "It's happened over and over and over again. So it's contamination?" "Yes, yes, absolutely."

A hundred years ago, everybody blamed this contamination as the cause of cancer. I have the literature. There were thousands of articles written on bacteria—bacterial

You and I have no trouble getting rid of a cough or a cold in a week or two.

We can get rid of cancer: make the cancer *look* like a cough or a cold by sticking cough or cold particles on it, and the body will attack it, destroy it and remove it.

TABLE 1: CASE STUDIES OF AIDS PATIENTS TREATED WITH INDUCED REMISSION THERAPY

CASE #1 (32-YEAR-OLD MALE)

Before entering into therapy:
Viral count 312,000
T-helper count 150

After one week:
Viral count 10,000
T-helper count 650

CASE #2 (49-YEAR-OLD MALE)

Before entering into therapy:
Viral count 78,000
T-helper count 89

After one week:
Viral count 7,000
T-helper count 438

and fungal organisms—being the cause of cancer. But, as technology gets more and more advanced, we have to reject what's obvious; and when we reject what's obvious, the truth becomes very hard to find.

So how could I prove to these people that these organisms are actually intricately involved in the cancer process or in the AIDS process?

The first thing to do is to grow a bunch of them out of some cancer cells, inject them into a few animals and see how many animals get cancer—and a lot of them do. Because the bug does not kill the animal, the animal develops cancer. In a strange way, it actually appears that developing the cancer makes the animal live longer.

Now, let me warp your minds a little bit here. Believe me, what I'm about to say to you is just a theory, and it has no bearing at all on the efficacy of the therapy, but what if these bugs can't entice an immune response? They are contained in the middle of the cancer; the body is not doing anything to fight them, and yet they're not spreading. What's containing them? What if cancer isn't really the enemy? What if it's the body's last-chance attempt at getting these bugs and localising them in an area so they don't spread and kill us in a hurry? What if cancer is actually doing us a favour? Is that why every time we fry a cancer lesion with radiotherapy and chemotherapy, the whole thing then comes back and explodes all over the place because we're actually releasing the cause from its entrapment? Just a theory!

This therapy at the very least can control the disease, and at best can cause dramatic, rapid improvement. There are many cases of cancer tumour reducing to half its size within a week or two.

For example, fig. 1a shows the mammogram of a breast cancer in a 65-year-old woman. After 10 days of treatment, the breast is

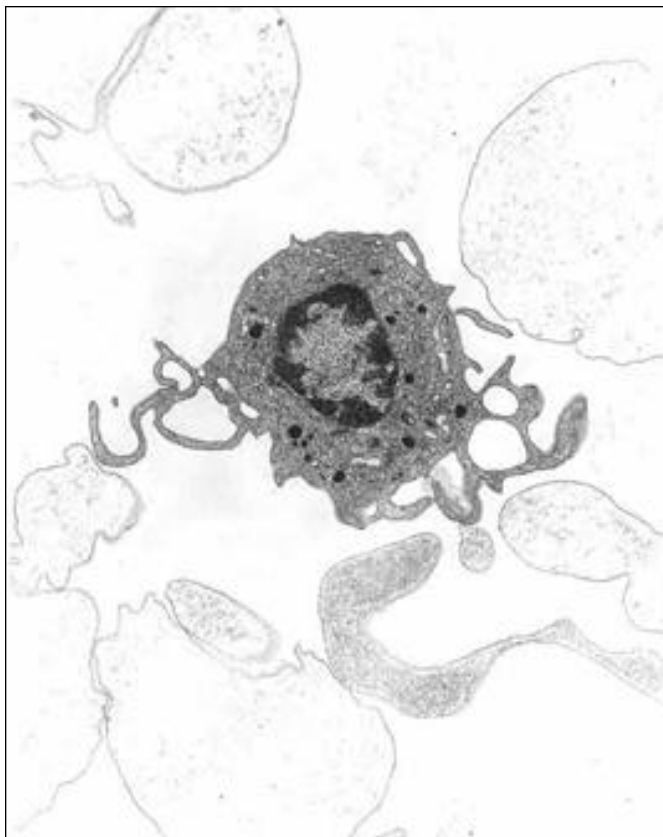

Fig. 3a: Electron microscope photograph shows the fragmenting cell full of HIV particles.

normal (fig. 1b). Fig. 2a shows a case of non-Hodgkin's lymphoma in a 32-year-old woman. After two weeks of treatment, her lymphoma was considerably reduced in size (fig. 2b).

It's unheard of to be able to do that and not have significant die-off or toxic effects—and yet they don't exist with this treatment. When you follow nature and follow the guidelines of what happens in spontaneous remission, Induced Remission Therapy can achieve cures with minimal side effects.

I didn't choose the public forum to come here and speak to you today. Please understand me: I would much rather be addressing medical practitioners, peers, and getting this out not as an alternative therapy but as a conventional therapy. I've spent 12 years trying to get my research published in the conventional literature, and 12 years going from hospital to hospital and being treated like something they'd stepped in.

In light of what I read in the paper today—somebody wrote an article condemning this conference—it appears that the message being sent by that person is that if the conventional medical establishment in all its holiness doesn't agree with a concept or a therapy, then the public is just too stupid to be able to understand it fully and evaluate it for themselves. The attitude is that the public is just so dumb that they shouldn't be given the opportunity. Well, my apologies to the author, but the greatest fool I know is a blind fool who'll say opinions about things he hasn't even bothered experiencing or investigating himself.

In this "Kevorkian age", as I call it, where people champion the concept of death with dignity when faced with suffering, pain and disease, I'm offering a technology that can end suffering, pain and disease; and I pray that the emphasis will shift now from trying to support death with dignity to championing life with dignity.

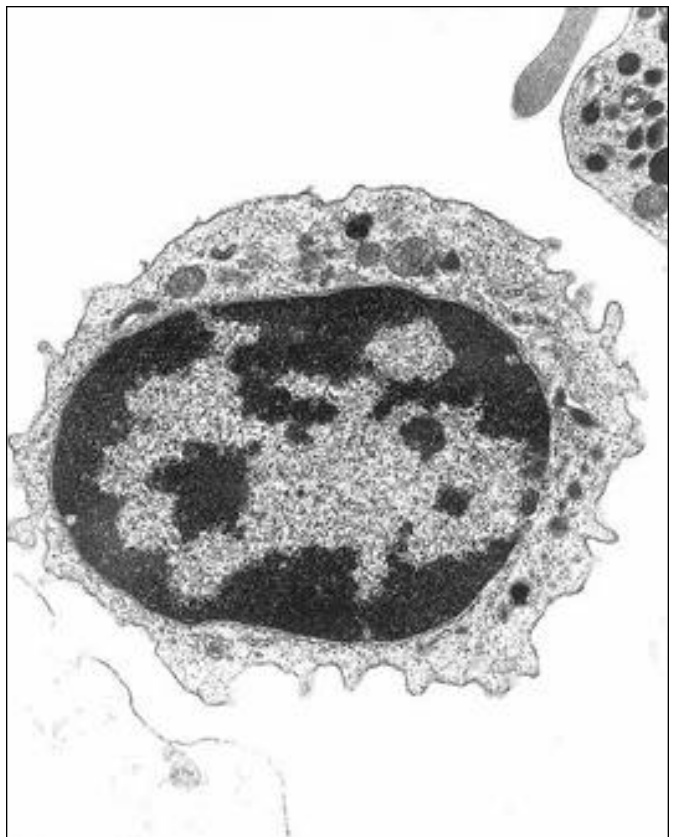

Fig. 3b: Photograph shows the same cell three days later.



Fig. 3c: Photo taken six days after vaccine treatment shows fewer viral particles per cell.

INDUCED REMISSION THERAPY: 1998 UPDATE

After years of lectures, presentations to peers and public appearances as well as numerous radio, television, newspaper and magazine appearances, I find that conventional medicine still has little awareness of the efficacy of my therapies—as evidenced, for example, in the advances achieved using IRT in AIDS remission (see table 1).

Any doctor can make amazing claims, but independent, unbiased testing is a credible way to determine the efficacy of a treatment. It would not only document the effectiveness of my vaccines but would also stir interest in any promising new therapy.

So I brought case studies of AIDS patients I'd treated to Cedar Sinai Medical Center for evaluation. Dr Shlomo Melmed was impressed with the results, and at his suggestion I sent samples of my vaccine to the AIDS and Immune Disorders Center's Division of Infectious Diseases for *in vitro* analysis. The clinical analysis performed by Dr Eric Daar indicated that out of the 22 samples tested, 20 of them showed 99% efficacy in neutralising HIV-1.

This analysis was followed up with an independent evaluation by University of Southern California clinical laboratories. This involved the electron microscopy of blood samples taken by a control group infected with HIV. This group yielded over 100 photos that demonstrate the attack, death, disintegration and purge of the HIV virus. The PhD who conducted this test remarked that "the number of intact viral particles has declined for each patient following vaccine administration at a level approximating 50%".

Examples of this progression from attack to purge are shown in figures 3a to 3d. The first electron microscope photograph (fig. 3a) shows the fragmenting cell full of HIV particles. The next photo (fig. 3b) shows the cell three days later, with improved stability and decreased viral particle count. The third photo (fig. 3c) was taken six days after vaccine treatment and shows fewer viral

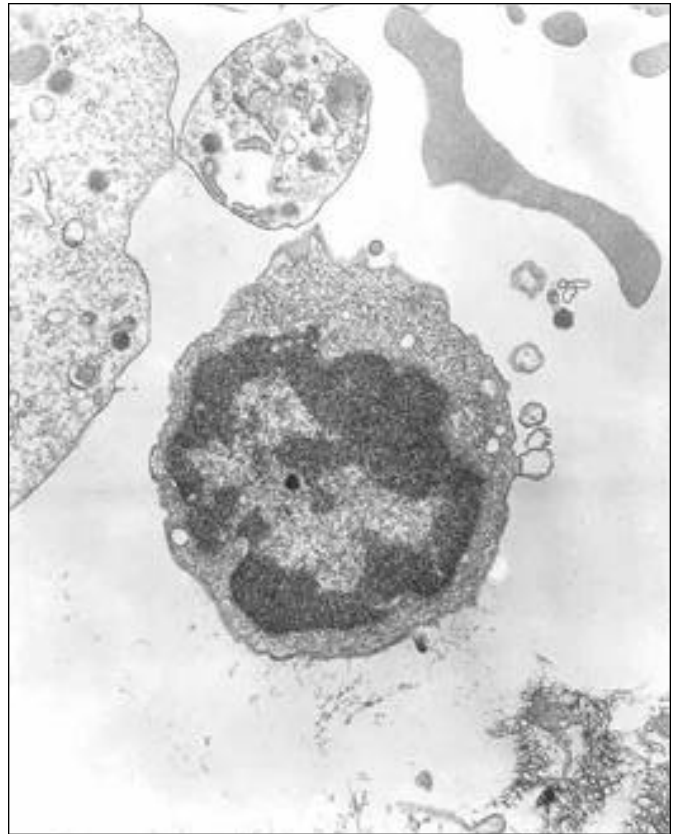

Fig. 3d: Photograph taken nine days after therapy shows no intracellular viral particles and the now-visible cell nucleus.

particles per cell. The final photo (fig. 3d), taken nine days after therapy, shows no intracellular viral particles and the now-visible cell nucleus.

This evidence from the cellular level demonstrates that AIDS and cancer can be attacked genetically without causing significant damage to the healthy, fast-multiplying cells needed to maintain a healthy life.

You'd think that the media, the medical community and others would be alerted to the fantastic results of this treatment.

It's hard to imagine that institutes entrusted with the public faith and public funds to discover and research new therapies would delay the application of life-saving technology and treatments. It was my hope that knowledge of IRT would be disseminated and the FDA would allow the practice of this therapy upon the countless AIDS and cancer victims who had little hope otherwise. But these doctors and medical institutes denied having any affiliation with me. They denied the impressive test data and even denied knowing me—until forced to declare otherwise before a judge in a civil legal action in San Diego, CA (case no. 700406). It was their incomprehensible behaviour that led me to bring a lawsuit, if for no other reason than to make these test results a record of the court, but I had to pursue these medical organisations so as to have access to further laboratory evidence.

We tend to worship our doctors as gods who will save us from diseases. If these false gods let us down, is it not time to take back responsibility for our lives and well-being? As the public begins to learn of this promising healing technology, IRT, they demand to know why it is being withheld.

Continued on page 87

TAMOXIFEN

A Major Medical Mistake?

Once praised for its benefits in preventing breast cancer recurrence, the lucrative pharmaceutical drug tamoxifen is now implicated in causing dangerous side-effects including other types of cancers.

by Sherrill Sellman © 1998

Light Unlimited Productions
Locked Bag 8000-MDC
Kew, Victoria 3101, Australia
Telephone: +61 (0)3 9249 9591
Fax: +61(0)3 9855 9991
E-mail: golight@netspace.net.au

In the early 1970s, a shameful chapter closed on the widespread use of a known carcinogenic and endocrine-disrupting drug called DES (diethylstilboestrol), the first synthetic, non-steroidal oestrogen drug. Against the advice of its creator, Sir Charles Dodd, between four and six million American and European women and 10,000 Australian women innocently used DES for the prevention of miscarriage and pregnancy complications.

In addition, DES became a popular though unproven drug for a variety of other conditions. It was used for the suppression of lactation, the treatment of acne, the treatment of certain types of breast and prostatic cancer, and as an inhibitor of growth in young girls, an oestrogen replacement in menopause and a "morning after" pill.

It would take 30 years to accept what laboratory tests had indicated as early as 1938—that DES was a highly dangerous and harmful drug. It was reported that, 20 years after taking DES, mothers had a 40 to 50 per cent greater risk of breast cancer than non-exposed mothers. In addition, the children of DES mothers showed a high incidence of reproductive abnormalities, miscarriages, vaginal cancer, testicular cancer, sterility and immune dysfunction. In fact, it is feared that repercussions of this drug will be felt for generations to come.

The irony of this entire debacle is that the medical establishment finally acknowledged that DES was useless in preventing miscarriages. Thus, DES, another disastrous experiment on women, was added to the long list of major medical blunders.

Out of this early research, a new drug appeared on the horizon which would be soon be heralded as a shining star in the war against the growing epidemic of breast cancer. In the late 1960s the pharmaceutical industry developed a drug called "tamoxifen". As a synthetic, non-steroidal compound with hormone-like effects (many of which are poorly understood), tamoxifen has a similar structure to DES. In fact, it was observed that tamoxifen caused the same abnormal changes seen in cells of women taking oestradiol and DES.¹ This similarity raised alarm bells for some.

Pierre Blais, well known as a drug researcher who was ejected from Canada's health protection bureaucracy when he spoke out about silicone breast implants, describes the story of tamoxifen as "the story of modern drug design which produces garbage drugs". He says, "Good drug design ceased, unfortunately, in the 1930s." Tamoxifen, Blais asserts, "...is a garbage drug that made it to the top of the scrap heap. It is a DES in the making."²

Blais's dire predictions were ignored with the promise of a potential drug treatment for breast cancer. Tamoxifen was first approved by the US Food and Drug Administration (FDA) for use as a birth-control pill; however, it proved to induce rather than inhibit ovulation. Although tamoxifen didn't work as a contraceptive, it was found to lower mammary cancer rates in animals. Animal studies showed that tamoxifen prevented oestrogen from binding to receptor sites on breast tissue cells. Tamoxifen also reduced the incidence of breast cancer in rodents after administration of a breast-carcinogenic substance. This discovery provided the impetus to study its effects in treating human breast cancer.

Oestrogen is the common link between most breast cancer risk factors, i.e., genetic, reproductive, dietary, lifestyle and environmental. It both stimulates the division of breast cells (healthy as well as cancerous) and, especially in its 'bad' form, increases the risk of breast cancer. Thus, hormonal drugs such as tamoxifen that block the effects of oestrogen on the breast were expected to reduce the risk of breast cancer recurring in women treated for breast cancer.³

Tamoxifen acts as a weak oestrogen by competing for oestrogen receptors much as

phyto-oestrogens do. Like phyto-oestrogens, tamoxifen has mild oestrogenic properties but is considered an anti-oestrogen since it inhibits the activity of regular oestrogens. More accurately, tamoxifen is an oestrogen-blocker. It fights breast cancer by competing with oestrogen for space on oestrogen receptors in the tumour tissue. Every tamoxifen molecule that hooks onto an oestrogen receptor prevents an oestrogen molecule from linking up at the same site. Without a steady supply of oestrogen, cells in an oestrogen-receptor-positive (ER+) tumour do not thrive and the tumour's ability to spread is reduced.⁴

However, tamoxifen exhibited two conflicting characteristics. It could act either as an anti-oestrogen or as an oestrogen. Therefore, while tamoxifen is anti-oestrogenic to the breast, it also acts as an oestrogen to the uterus and, to a lesser extent, the heart, blood vessels and bone. So, although it initially showed the tendency to counter breast cancer recurrence, it would soon be revealed that it also promoted particularly aggressive uterine and liver cancers, caused fatal blood clots and interfered with many other functions.

Doctors, however, were quick to jump on the tamoxifen bandwagon, turning a blind eye to its more injurious tendencies. Starting in the 1970s oncologists began using tamoxifen to treat women with cancer, often in combination with other drugs, radiation or surgery such as lumpectomy and mastectomy, with modest success. Like DES, tamoxifen's benefits were then extended for use as a preventive against osteoporosis and heart disease.

Today, doctors are treating about one million American breast cancer patients with tamoxifen, about 20 per cent of them for more than five years. As studies published in the *New England Journal of Medicine* in 1989 and the *Journal of the National Cancer Institute* in 1992 showed, women with breast cancer who took tamoxifen reduced their chances of developing cancer in the other breast (counterlateral cancer) by about 30 to 50 per cent.⁵

These findings would later be challenged.

Tamoxifen is now recommended for all premenopausal women with hormone-positive cancers, as well as for most postmenopausal women with breast cancer and/or a growing number of women with hormone-negative cancers. Tamoxifen is currently used by more women with breast cancer than any other drug.⁶

Tamoxifen (brand name Nolvadex) is now the most widely prescribed cancer medication in the world. It generated revenues of US\$265 million in 1992. By 1995, worldwide sales of Nolvadex reached \$400 million.⁷ And at AUD\$90 for one month's supply, it doesn't come cheap (the Australian Pharmaceutical Benefits Scheme covers \$70).

Tamoxifen was developed by UK-based Imperial Chemical Industries (ICI), one of the world's largest multinational chemical corporations. Zeneca, an ICI subsidiary, is responsible for manufacturing and marketing the hormone and is now the world's largest cancer-drug company.

It is no surprise that ICI's profits come from playing both sides of the cancer industry. ICI's agrochemical division, which includes Zeneca, manufactures chlorinated and other industrial chemicals including herbicides. All are poisonous, and many are known endocrine-disruptors that have been incriminated as causes of breast cancer. ICI's profits swell by manufacturing chemicals that on the one hand *cause* breast cancer, and on the other hand

Like phyto-oestrogens, tamoxifen has mild oestrogenic properties but is considered an anti-oestrogen since it inhibits the activity of regular oestrogens. More accurately, tamoxifen is an oestrogen-blocker.

reputedly *cure* breast cancer.

LIMITED BENEFITS OF TAMOXIFEN

Tamoxifen's benefits are determined by several factors:⁸

- Postmenopausal women who are ER-positive (have a positive oestrogen receptor status) get the most benefit.
- For postmenopausal women who are ER-negative, the benefits appear to outweigh the risks.
- For premenopausal women who are ER-positive, it's a tough call. Potential benefits are small.

- Premenopausal women who are ER-negative receive virtually no benefit.
- Tamoxifen is more effective in women who have cancer in their lymph nodes than in those whose nodes are cancer-free.

In 1992 the *Lancet* published a review of a number of studies in which a total of 30,000 breast cancer patients were randomly assigned either to take tamoxifen or not. The average patient in this collaborative study was followed up for between five and six years. Of the patients taking tamoxifen, 74.4 per cent survived, as compared with 70.9 per cent in the non-tamoxifen group—a less-than-impressive improvement.

The report found that the group helped most consisted of postmenopausal women with ER-positive status. The study went on to report that premenopausal women who are ER-negative had absolutely no benefit from taking tamoxifen.⁹



Despite tamoxifen's proven ability to reduce breast cancer recurrence in postmenopausal women, major studies have shown that tamoxifen reduces death from breast cancer only marginally.¹⁰ The majority of women who take tamoxifen live no longer than women who do not take it.¹¹ Furthermore, some breast cancers learn how to use tamoxifen to stimulate their growth.

The benefits of tamoxifen are limited. Virtually all women who take it become resistant within five years.¹² A recent randomised, controlled study showed that tamoxifen reached its maximum protective effect on breast tissue with women who took it for five years. Taking it for five more years didn't offer any more protection, and may actually have caused more cancers. In other words, after a while the breast cells become resistant to tamoxifen and actually start to be fed by it.¹³

This result surprised the researchers. According to Dr Susan Love, author of *Dr Susan Love's Hormone Book*: "This is a dramatic example of why you need good, long-term studies. If we had based all of our recommendations on the five-year data without doing further studies, we would have had women taking tamoxifen forever. So convinced were we that tamoxifen was a wonder drug that the only reason researchers did the later study at all was to prove it wrong. Luckily, we found out that we were wrong in time to prevent doing further damage. We have learned, not for the first time, that more isn't always better."¹⁴

TAMOXIFEN'S DARK SIDE

While the initial findings of tamoxifen's role in breast cancer treatment seemed so promising, as with so many of the synthetic hormone drugs, further research presented grave concerns for its widespread use. In fact, the *MIMS Annual* lists 25 adverse reactions to tamoxifen; some of these can be fatal.

Menopausal Symptoms

Tamoxifen often induces menopausal symptoms in menstruating women. About half of these women experience hot flashes. Fluid retention and weight gain occur in about 25 per cent of women and can be controlled by reducing the dose. Vaginal discharge and vaginal atrophy are additional symptoms. Some studies have also found that premenopausal users are at risk of developing accelerated bone-mineral loss and osteoporosis.

Menstrual irregularities also occur in premenopausal women. Amenorrhoea (absence of the menstrual cycle) often results and can be permanent.

Eye Damage

According to a 1978 study in *Cancer Treatment Reports* and another published in *Cancer* in 1992, about six per cent of women taking even low-dose tamoxifen suffer damage to the retina and corneal opacities and decreased visual acuity. Irreversible corneal and retinal changes can occur in those taking 20 mg of tamoxifen twice a day (twice the usual dose). These changes may have no immediate effect on visual acuity, but may predispose the eyes to later problems including cataracts.

Blood Clots

Tamoxifen irritates the walls of the veins, and inflammation (a natural healing response to irritation) follows. The constant irritation and inflammation weakens the veins, causing bleeding, clotting, thrombophlebitis and, in the worst cases, obstruction of the blood vessels serving the lungs, which can be deadly and can occur with little warning. The incidence of thrombophlebitis in women using oral contraceptives is generally regarded as significant (1 in 2,000); however, with tamoxifen it's 30 times greater.¹⁵

Several studies, including one reported to the FDA's Oncological Drugs Advisory Committee by the National Surgical Adjuvant Breast and Bowel Project in 1991, showed that the risk of developing life-threatening blood clots increases about seven times in women taking tamoxifen.¹⁶

Psychological Symptoms

Depression has been reported as a potential side-effect of tamoxifen in 30 per cent of women. Cases have been reported of an inability to concentrate.

It is important that patients observe their moods and mental states. If it is suspected that tamoxifen is causing depression or lack of concentration, it is suggested that a period of tamoxifen avoidance be considered.

Other Symptoms

Tamoxifen can trigger asthma attacks in some sensitive patients.

Changes to the vocal cords resulting in impairment of singing and speaking abilities are occasionally caused by tamoxifen.

CARCINOGENIC EFFECTS

It wasn't long before laboratory studies showed that tamoxifen acted as a carcinogen. It has been found that tamoxifen binds tightly and irreversibly to DNA, the genetic blueprint of a cell, causing a cancerous mutation to take place. Even Australia's conservative National Health and Medical Research Council (NHMRC) warned that no amount of tamoxifen is safe when it comes to carcinogenic effects.

In California there is a law called "Proposition 65" that requires the state to publish and maintain a list of all known carcinogens. In May 1995, the

state's Carcinogen Identification Committee voted unanimously to add tamoxifen to its list.

Following suit, in 1996 the World Health Organization formally designated tamoxifen a human carcinogen, grouping it with 70 other chemicals—about one quarter of them pharmaceuticals—that have received this dubious distinction.

Liver Cancer and Liver Disease

Tamoxifen is toxic to the liver, and there have been reports of acute hepatitis in patients treated with tamoxifen. Liver damage has occurred in every animal given tamoxifen. According to Gary Williams, medical director of the American Heart Foundation, tamoxifen has been shown in animal studies to be a "rip-roaring" liver carcinogen, inducing highly aggressive cancers in about 12 per cent of rats.¹⁷

In California there is a law called "Proposition 65" that requires the state to publish and maintain a list of all known carcinogens.

In May 1995, the state's Carcinogen Identification Committee voted unanimously to add tamoxifen to its list.

The latest human studies show a sixfold increase in liver cancer among women taking tamoxifen for more than two years.¹⁸ Liver failure and tamoxifen-induced hepatitis, although rare, have been reported. Even Zeneca admits that tamoxifen is a liver carcinogen—while nevertheless aggressively promoting its use.

Uterine (Endometrial) Cancer

As early as 1967, ICI scientists noted that "tamoxifen persists for some days in the uterus". In rats, a tamoxifen metabolite (a breakdown compound almost similar in structure to the original) was found to influence the uterus to be more receptive to oestrogen. (The more oestrogen, the greater the chance of unnatural cell-division leading to cancer.) ICI also reported liver carcinogenicity of tamoxifen as well as both ovarian and testicular tumours in mice in its description of the drug in the standard *Physicians Desk Reference*.

Uterine growths such as polyps, tumours, endometrial thickenings and cancers occur in a significant number of women taking tamoxifen. One study detected abnormal endometrial cells in subjects the day after the first tablet was taken.¹⁹ Precancerous uterine and endometrial changes were seen in 10 per cent of the women taking tamoxifen in a recent study. The higher the dose of tamoxifen and the longer it is taken, the greater the risk of changes. Women taking the standard dose of 20 mg for two years run a risk of uterine cancer that is 2 to 3 times greater than normal. After five years, the risk is 6 to 8 times greater.²⁰

In February 1996 a review by the International Agency for Research on Cancer, composed of scientists from various countries, definitively concluded that "there is sufficient evidence to regard tamoxifen as a human carcinogen that increases a woman's risk of developing cancer of the endometrium, the inner lining of the uterus".²¹

A large Swedish study linking tamoxifen to uterine cancer forced Zeneca to send letters in April 1994 to 380,000 physicians across the USA, in defence of the drug. The Swedish researchers had studied 1,371 breast cancer patients who took 40 mg per day for two to five years and found that there was a six-fold increase in uterine cancer among those patients who took tamoxifen when compared to 1,327 who did not. A second study involving patients who took 20 mg per day (the recommended dose) also showed a marked increase in uterine cancers compared with the control group.²²

When the news came out that breast cancer patients who took tamoxifen for five years or longer (the same regimen that seems to prevent recurrence) might have tripled their risk of uterine cancer, British cancer researcher Richard Peto, head of the cancer research unit at Oxford University, sought to dismiss it. If caught early, he said, endometrial cancer seldom kills, so "it's no big deal". That statement infuriated critics who noted that the treatment for uterine cancer is hysterectomy. Dr Adriane Fugh-Berman, a leading women's health activist, angrily responded: "To some of us, it is a big deal to lose your uterus."

Shortly after Peto's flip dismissal of uterine cancers, researchers

at the M. D. Anderson Cancer Center at Houston and at Yale University School of Medicine discovered that breast cancer patients who develop uterine cancer while using tamoxifen are likely to have a fast-moving, lethal form of the disease.²³

It should be noted that tamoxifen has also been associated with gastrointestinal cancers.

Breast Cancer

The premise for taking tamoxifen is its supposed role in protecting breast cancer patients from recurrence of the cancer. It was further postulated that it prevented breast cancer from occurring in the opposite breast (contralateral).

However, disturbing findings continue to surface, challenging tamoxifen's effectiveness. In 1992 the *New England Journal of Medicine* showed that tamoxifen may reduce the incidence of contralateral cancer, but this was demonstrated only in premenopausal women and only in three out of eight trials. In another 1992 study, reported in *Octa Oncologica*, it was shown that tamoxifen not only failed to reduce contralateral cancers in premenopausal women, but it actually increased their incidence.²⁴

The irony of tamoxifen is that, while widely publicised as the leading treatment against the recurrence of breast cancer, it is a known and listed carcinogenic substance.

Heart Disease and Osteoporosis

Another promise of tamoxifen was its supposed protective benefits for the heart and bones. It was theorised that its oestrogenic properties would help reduce heart disease and osteoporosis in women, but once again the theory crumbled under the weight of hard facts.

Several trials with tamoxifen failed to show that it has any effect on bone density and thus on prevention of osteoporosis. In three other trials, bone density increased slightly in lower spinal vertebrae but not in longer bones or hip bones which are particularly susceptible to fractures and potentially fatal com-

plications.

Initial data seemed to indicate that it decreased the incidence of heart attacks, but they have been disproved by more recent studies. According to Dr Susan Love: "It doesn't seem to have a bad effect on lipids, but that's a far cry from preventing heart attacks."

A detailed review of the drug's alleged protective cardiovascular effects prompted the British National Heart, Lung and Blood Institute, a once strong proponent of tamoxifen, to withdraw its support because the evidence of benefit proved so inadequate.²⁵

According to the January 1996 issue of *The Network News*, it was reported at a closed-door meeting of the National Cancer Institute that tamoxifen failed to prevent heart disease in breast cancer patients.

THE BREAST CANCER PREVENTION TRIAL

Based far more on wishful thinking than on science, the US National Cancer Institute (NCI) leaped to the conclusion that tamoxifen's anti-oestrogenic effects in relation to breast cancer

Uterine growths such as polyps, tumours, endometrial thickenings and cancers occur in a significant number of women taking tamoxifen.

One study detected abnormal endometrial cells in subjects the day after the first tablet was taken.

treatment meant that the drug would prevent breast cancer from developing in healthy women.

Disregarding all the research implicating tamoxifen with serious and potentially fatal side-effects, the NCI launched a US\$60 million breast cancer prevention trial in April 1992, aiming to recruit 16,000 healthy women in the United States, Europe, Canada, Australia and New Zealand. Still ongoing, the trial now involves 13,000 healthy women over the age of 35 who are considered at high risk. Australia has recruited 1,350 women, with a target of 2,500. For five years, half the women receive tamoxifen and half receive a placebo. The drug is supplied free of charge by manufacturer Zeneca.

Dr Samuel Epstein, Professor of Occupational and Environmental Medicine at the University of Illinois School of Public Health and author of *The Breast Cancer Prevention Program*, raises serious concerns. "Unfortunately, this misguided and dangerous approach to prevention stems from the entrenched fixation of the NCI on the use of chemical drugs to prevent cancer which may have been induced by chemical pollutants, medical technology (such as radiation from X-rays) and carcinogenic/oestrogenic drugs in the first place. Instead of attempting to reduce the carcinogenic chemical burden under which we struggle to maintain our health, the NCI believes that the solution is to add more chemicals to the mix."

Dr Susan Love concurs: "It is a sad state of affairs when we have to add yet more chemicals to counteract the effects of other chemicals."

This attitude extends to the way the NCI treats the women in the trial. They are given no guidance on alternative protective measures such as increasing exercise, maintaining a healthy weight, eating a protective diet and avoiding exposure to environmental carcinogens; nor are they being fully informed about the serious risks of tamoxifen.

Dr Lynette Dumble, Senior Research Fellow in History and Philosophy of Science at the University of Melbourne, believes that the global trial to prevent breast cancer with tamoxifen is a modern and very large chapter of "medical imperialism". Back in October 1994 she commented on ABC TV's *Quantum* science program that the tamoxifen trial was the medical equivalent of mutilating surgery which prevents a woman from developing breast cancer by cutting off both her breasts.

Dr Dumble sees women as vulnerable guinea pigs for the trial, and questions both the breast cancer risk of healthy women volunteering for the trial (how can you tell whether fate or tamoxifen prevents a woman from developing breast cancer?) and the terms of the trial's positives and negatives (if a woman dies of tamoxifen-related endometrial or liver cancer, does this count as a tamoxifen success in preventing breast cancer?).

It seems absurd, but why would the powers-that-be continue to promote a trial that promises to substitute one cancer for another in otherwise healthy women? Once again, healthy women are targeted as the guinea pigs for a drug treatment that has already been proven to be a cause of a variety of cancers including breast cancer. In the case of tamoxifen, medical research has once again taken a back seat to profits. It is the population that is at risk. The cancer establishment would certainly be eager to prove a tamoxifen-prevention role, since it would then open up another huge, billion-dollar market.

ALTERNATIVES TO TAMOXIFEN

While the cancer establishment continues to invest vast amounts of money into research, manufacturing and trialling of harmful drugs for the prevention and hopeful cure of breast cancer, there are safer and more effective options that already exist.

Oestriol, one of the oestrogens produced by the ovaries, is considered a safe oestrogen in that it has been shown to inhibit breast cancer. Dr Henry Lemon and his colleagues conducted a study in women who already had breast cancer that had spread to other areas of the body. One group was given oestriol and another not. At the end of the

study, 37 per cent of those women who received oestriol had either a remission or an arrest of their cancer.²⁶ Might not oestriol, a natural, safe hormone with almost no side-effects, be able to accomplish what tamoxifen does but without the toxic side-effects?

There is also convincing evidence that natural progesterone has an important role in breast cancer treatment and prevention. A study conducted in 1981 at Johns Hopkins University revealed that when a group with a low progesterone level was compared with a normal-level progesterone group, it was found that the occurrence of breast cancer was 5.4 times greater in the women in the low progesterone group. That is, the incidence of breast can-

Once again, healthy women are targeted as the guinea pigs for a drug treatment that has already been proven to be a cause of a variety of cancers including breast cancer.

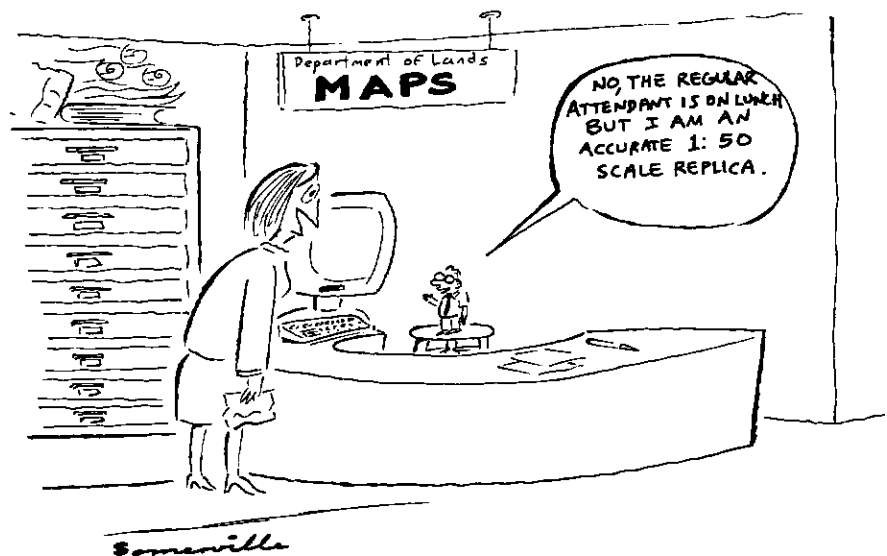

cer in the low progesterone group was over 80 per cent greater than in the normal progesterone group. When the researchers looked at the low progesterone group for all types of cancer, they found that these women experienced a tenfold increase in all malignant cancers, compared to the normal group.

In a 1995 study published in the *Journal of Fertility and Sterility*, researchers found that women using a topical progesterone cream had dramatically reduced breast cell multiplication rates compared to women using either a placebo or oestrogen. This exciting study demonstrated that natural progesterone creams impressively decreased breast cell proliferation rates.²⁷

Lifestyle factors also play a significant role. In a prospective study of 25,624 Norwegian women aged 20 to 54, after an average of 14 years of follow-up the investigators found strong evidence that everyday exercise, both at work and at leisure, reduced the breast cancer risk. Women who exercised at least four hours a week during leisure time were found to have a 37 per cent reduction in risk of breast cancer, compared with sedentary women. The study found that the more time spent exercising, the lower the breast cancer risk.²⁸

As Dr John Lee pointed out in his best-selling book, *What Doctors May Not Tell You About Menopause*: "Herbs and food contain phyto-oestrogens. Their benefit parallels that of tamoxifen (without the adverse side-effects) in that phyto-oestrogens occupy oestrogen receptors and are less oestrogenic than those made by the body. Since it is now known that reducing caloric

intake reduces oestrogen levels, and recent studies find 46 per cent less breast cancer among women consuming more fruit and vegetables, it would seem that women interested in preventing breast cancer could make modest changes in diet and derive better and certainly safer results."²⁹

History continues to repeat itself. Time and time again women have been reassured that the wonder drugs or treatments offered them would be their salvation, only to discover they were exposed to harmful carcinogenic and mutagenic chemicals.

In addition to the DES debacle, the disasters of thalidomide, silicone breast implants, oestrogen replacement therapy and now tamoxifen (to name just a few) continue to demonstrate how readily women's lives have been sacrificed in the pursuit of profits. The warnings have been drowned out by the glossy advertising campaigns and the reassurances of "medical experts".

There are solutions to the breast cancer epidemic. However, they will be found more by altering lifestyle, dietary and stress factors, and reducing or eliminating exposure to the

many known toxic, carcinogenic chemicals that are polluting the environment, than by some miraculous drug discovery. It is also up to women not only to continue to become fully educated about safe health options but to demand them from health providers. Too many women have already been maimed and sacrificed to unproven and unsafe drug treatments.

It is widely believed that today's drugs are tomorrow's poisons. In the case of tamoxifen, tomorrow has already arrived.

It is widely believed that today's drugs are tomorrow's poisons.

In the case of tamoxifen, tomorrow has already arrived.

Endnotes

1. Weed, Susun S., *Breast Cancer? Breast Health!*, Ash Tree Publishing, Woodstock, New York, 1996, p. 203.
2. Batt, Sharon, *Patient No More: The Politics of Breast Cancer*, Spinifex Press, Melbourne, Australia, 1994, p. 118.
3. Epstein, Samuel S., MD, Steinman, David, LeVert, Suzanne, *The Breast Cancer Prevention Program*, Macmillan, New York, 1997, p. 145.
4. Rinzler, Carol Ann, *Estrogen and Breast Cancer*, Hunter House, California, 1996, pp. 148-49.
5. Epstein, *ibid.*, p. 146.
6. Weed, *ibid.*, p. 201.
7. Clorfene-Casten, Liane, *Breast Cancer: Poisons, Profits and Prevention*, Common Courage Press, Maine, USA, 1996, p. 93.
8. Austin, Steve, ND, Hitchcock, Cathy, *Breast Cancer: What You Should Know (But May Not Be Told) About Prevention, Diagnosis and Treatment*, Prima Publishing, Rockliff, CA, 1994, p. 102.
9. Early Breast Cancer Trials Collaborative Group, "Systemic treatment of early breast cancer by hormonal, cytotoxic or immune therapy", *The Lancet* (1992) 339, pp. 1-15,

- 71-85.
10. De Gregorio, M. and Wibe, V., *Tamoxifen and Breast Cancer*, Yale University, USA, 1994.
11. Batt, *ibid.*, p. 125.
12. De Gregorio and Wibe, *op. cit.*
13. Love, Susan, MD, *Dr Susan Love's Hormone Book*, Random House, New York, 1997, p. 264.
14. *Ibid.*, pp. 264-65.
15. Weed, *ibid.*, p. 204.
16. Epstein, *ibid.*, p. 149.
17. *Ibid.*
18. Weed, *ibid.*, p. 205.
19. Adler, T., "Study reaffirms tamoxifen's dark side", *Science News*, June 4, 1994, p. 356.
20. "Studies spark tamoxifen controversy", *Science News*, February 26, 1994, p. 133.
21. Nesmeth, Jeff, "Breast Cancer Drug Increases Risk", *The Atlanta Journal/The Atlanta Constitution*, February 22, 1996.
22. Clorfene-Casten, *ibid.*, p. 89.
23. Rinzler, *ibid.*, p. 152.
24. Epstein, *ibid.*, p. 146.
25. *Ibid.*, p. 148.
26. Northrup, Christiane, MD, *Women's Bodies, Women's Wisdom*, Bantam Books,

- New York, 1996, p. 158.
27. Sellman, Sherrill, *Hormone Heresy: What Women MUST Know About Their Hormones*, GetWell International, USA, 1997, pp. 107-108.
28. Thune, Inger, MD et al., *New England Journal of Medicine*, May 1, 1997.
29. Lee, John R., MD, *What Doctors May Not Tell You About Menopause*, Warner Books, New York, 1996, p. 220.

About the Author:

Sherrill Sellman, psychotherapist, lecturer, writer on women's health issues and author of the best-selling book, *Hormone Heresy: What Women MUST Know About Their Hormones*, is committed to providing women with the most accurate health information enabling them to make safe, effective and informed choices. Sherrill lectures widely throughout Australia and internationally. She can be contacted at Light Unlimited, Locked Bag 8000-MDC, Kew, Victoria 3101; phone (03) 9840 6496, fax (03) 9855 9991; e-mail golight@ozemail.com.au.

UNLIMITED RECYCLING OF HEAT ENERGY

by Martin Gottschall, PhD © 1998

This paper gives a brief description of a device which the author believes can convert heat into electrical energy in an unlimited way.

The conversion of heat into mechanical, electrical and other forms of energy has been found to be governed by certain limitations which have been embodied in what is now known as the Second Law of Thermodynamics. It is generally held that all possible processes that convert heat to other forms of energy are subject to this law, although not all of them have yet been tested.

Over the decades, many inventions have been put forward for which it has been claimed or implied that the second law does not apply. In many cases the inventors unknowingly used the very processes on which this law is based, and so their inventions had to fail.

James Clerk Maxwell contributed to our understanding of heat, and must have reflected on the inner workings of the second law because he invented what we now call "Maxwell's demon", an imaginary entity which can sort the molecules of a gas into a high- and a low-energy collection, thereby overcoming the second law by creating a hot and cool gas body without expending a significant amount of energy.

Maxwell's solution was on the atomic and molecular scale. With the development of quantum theory in the first third of this century, scientists found that Maxwell's demon would need energy to do his sorting after all, because he needed energy (light) by which to see, and this energy expended could exceed the gains achieved. Thus it seemed that the second law had triumphed on the molecular scale as well.

In the author's view, this conclusion might have been a touch hasty. We do not have to operate

on the molecular scale, the scale of one-tenth of a nanometre. If we go about 100 times higher, to a scale of about 10 nanometres (nm), the quantum restriction is 100 times weaker—and Maxwell's demon is there, waiting to be put to use.

The principles on which this proposal is based were discovered by the author in about 1960. A paper based on these was submitted to the journal *Nature* in 1972. At the same time, about 20 copies with accompanying letters were sent to a selection of national embassies. The writer believed that the proposal had a good chance of being practical, and governments should be forewarned so that the new technology could be brought into use without undue dislocation and so that existing energy technologies could be adapted. The submission was rejected, and the technology has clearly not yet come into public use.

Since 1972 there has been much progress in small-scale technology, particularly in what we call "nanotechnology". Perhaps this time, people with the necessary skills and resources will recognise the potential in this device and commit themselves to its development.

ELECTROSTATIC GENERATOR

The device works with heat energy on a scale of about 10 nm, and the "demon" is

"contact potential". Metals are a class of substance in which the naturally occurring charges (electrons) that surround every atom are free to move about within the substance. This makes metals electrical conductors. Non-metals have their electrons bound to atoms or molecules, and they exhibit little or no electrical conductivity.

Although electrons may move freely within a metal, they cannot readily escape into the space around the metal. For each metal, a certain amount of energy is needed to lift the electron into the surrounding space. Different metals require different amounts of energy for this. When two different metals touch, the metal having the greater attraction for electrons will attract electrons from the other metal and become negatively charged, and the voltage associated with this charge eventually stops the flow of electrons. This voltage is known as the "contact potential" of that metal pair.

Figure 1 shows an electrostatic generator based on contact potential. Small metal balls are confined to the space between two metal plates A and B. When the balls touch plate A, they acquire one excess electron because of contact potential. When they touch plate B, they give up any excess electrons they may possess, as well as one extra electron—which leaves them electron-deficient or positively charged. If

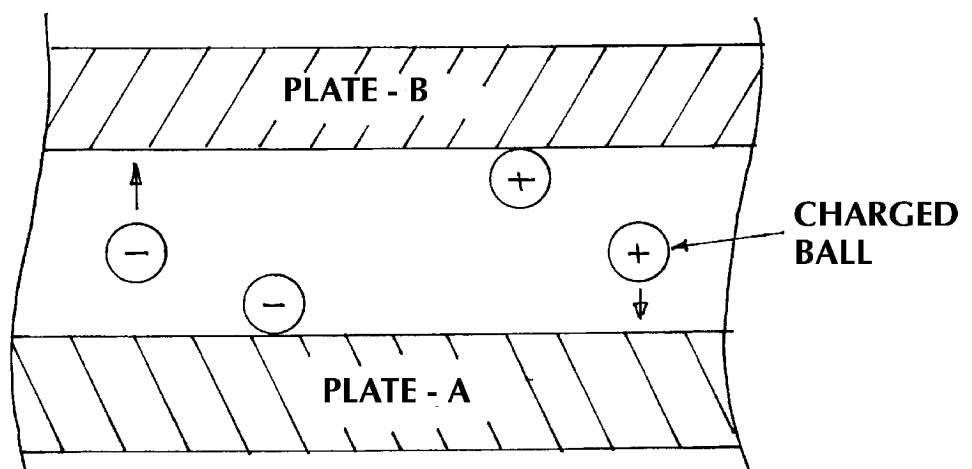

Figure 1: An electrostatic generator based on contact potential

we were to shake this device up and down, causing the balls to bounce between the plates, electrons would be transported from plate A to plate B. These electrons could be allowed to return through an external circuit and do work. We can regard this device as an electrostatic generator.

THERMAL CONVERTER

The electrostatic generator can become a thermal converter if we cause heat to do the shaking about of the balls. Heat energy is constantly trying to shake the balls. The energy available for this is proportional to the absolute temperature, T , and is calculated with the constant, k (Boltzmann's constant). When the balls are small enough, their agitation by heat energy fluctuations can make them bounce back and forth between the plates. At a diameter of 10 nm, the thermal activation of the balls is sufficient, and we have the possibility of a thermal converter producing a spontaneous flow of current as long as the temperature is maintained.

A possible thermal converter operating at ambient temperature is shown in figure 2. It differs from figure 1 in that its scale is now defined and the plates are coated with a thin layer of insulating material. One would think that this insulator would stop the electric charging process, but if the layer is thin enough then electrons can 'tunnel' through often enough to allow the con-

verter to operate as intended. The main function of the insulator is to reduce the electric force holding the charged ball to the plate. Heat energy does not kick just the balls around, it also kicks electrons around. As a consequence of the thermal activation of electrons, the charge on the balls may be neutralised or even reversed. When the polarity of electric charges is reversed, we have an internal leakage current which can reduce or even stop the current in the external circuit. Fortunately, careful calculation shows that under certain conditions the cell can generate power.

If the cell generated any power at all, however little, it would mean that the second law is not a universal law after all, and that there probably exist other methods which also work and are of practical value. Fortunately, the thermal converter can generate enough power to be of very great practical interest. With development, it can only get better.

One such improvement is the suppression or elimination of the internal leakage current. Figure 3 shows a version of the converter in which the layers of insulating material are replaced with semiconductor material which can still perform the insulator's function. Plate A is coated with n-type semiconductor, and the balls can get electrons readily enough but can give up electrons only with great difficulty. The p-type semiconductor on plate B acts in

reverse, and the cell now behaves like a diode with respect to the balls. Please note that the original analysis takes full account of the thermal activation of charges, and the claim that the converter works does not rely on this diode action.

Other improvements relate to the mass of the balls. By using hollow shells, their mass can be greatly reduced (we cannot make them smaller), which increases their speed and hence power output. The power of this device increases rapidly if the temperature at which heat is available is raised. Elevated temperature allows us to reduce the size and mass of the balls, and hence a larger number of balls per unit area move between more closely spaced plates at greater speed.

POTENTIAL APPLICATION OF THE THERMAL CONVERTER

A typical thermal converter would look like a stack of plates with air spaces between them. Air or water is drawn between the plates, keeping them warm. The power output is about one kW per kg of mass, and the average density is about 500 kg per cubic metre. This makes the converter powerful for its weight, and compact. For example, a 100 kW unit suitable for powering a car would have a weight of 100 kg and a volume of 0.2 cubic metres. The operation of the device is silent and vibration-free.

The converter could be used for both small- and large-scale power generation. If the electric power produced is expended in the locality of the converter, the environmental impact is very minimal because heat is taken from and returned to the environment at the same time. If the energy is exported to other places, as for example by electric transmission, then the environment of the converter is cooled.

It would be immediately useful in motor vehicles, ships, and industrial and domestic applications. For use in powering aircraft, a ratio of 10 kW per kg is desirable, and this application would need to await further development of the converter.

The converter is an intricate device requiring a high level of technology. A thousand cells might stack up to a thickness of

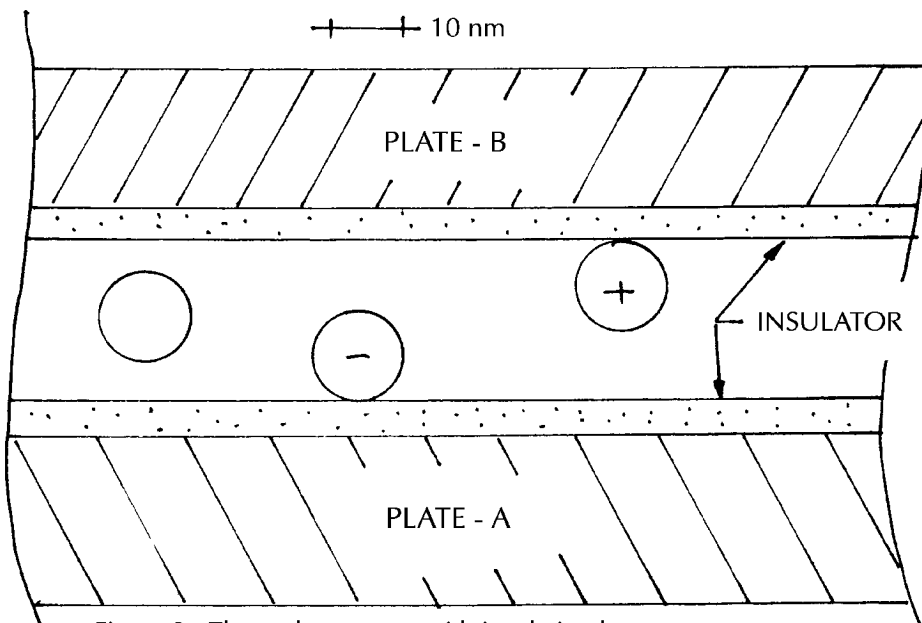

Figure 2: Thermal converter with insulating layers

NEWSCIENCE NEWSCIENCE NEWSCIENCE

one millimetre, and a typical unit might contain many thousands of cells. Initially their cost might compete with other power sources in only limited applications; and there would be an interval of perhaps a decade during which the converter could become competitive with power sources generally. This is the period during which foresighted government policies could smooth out dislocations that might arise.

When fully developed, the converter could be especially beneficial to economies and peoples whose energy costs are a large fraction of their cost of living. Its impact on economic and industrial activity would be in areas where energy is needed in large quantities. Fresh water is needed in large quantities, and the transport of water from places where it is available to where it is needed, or the conversion of sea water which is generally abundant around the planet, requires vast amounts of energy. The required energy is present in the water as heat, and can be taken directly from the water for the purpose of pumping and/or desalination.

The urgent need for mankind to learn to tread more softly as we manage and work with our ecosystem would create projects with a large energy component. Such things as de-polluting soils and waters, or the establishment of places of human habitation in the deserts, the oceans and underground where their environmental impact is less, would become feasible if a steady, reliable and sustainable source of energy were available.

The above comments apply equally to human habitats in space, on the Moon, Mars, Venus and Mercury, just as well as on Earth. Venus, in particular, is thought to be very hot. To survive in such an environment we need to keep heat out, and the converter is ideally suited for this. It is particularly sobering to realise that there is enough room, sunlight and material in our solar system to sustain habitats in space equivalent to several billions of Earths, and that every species of life we so wantonly destroy is actually billions of times more valuable as a vital component of these potential habitats than our

Earth-oriented perspective can appreciate.

The perpetual recycling of heat energy, which this converter makes possible, is, on the physical side, what an unlimited bank account is on the economic side. In recent decades there has been much 'limited' thinking. To be sure, the planet and its resources are finite, but the creative resources which we can bring to it need not be limited. When a finite number is multiplied by an infinite number, the product is also infinite.

It is altogether unnecessary to sink into some kind of despondency about the future prospects of mankind on or off this planet. What we should do, and with the greatest urgency, is to stop and/or transform all those activities which have the effect of diminishing our planetary resources.

The second law has influenced philosophical thought more than most other natural laws in that it points to a kind of 'heat death' of the universe. The repealing of this law is therefore likely to remove or at least change these notions of 'universal mortality'.

In particular, since living cells operate roughly on the scale of the converter, one can envision bacteria and organisms which derive their energy requirements by thermal conversion. Such organisms would

require neither food nor sunlight, and, provided they can obtain the necessary chemical substances to build and maintain their bodies, they can continue to exist in their environment indefinitely if it maintains a tolerable temperature range. From this perspective, almost every planet and many of the moons in our solar system have a thermal environment at some level of their structure that could be a habitat for life.

Note: A larger version of this paper, which sets out a mathematical assessment of its viability, may be obtained from the author by return airmail for a fee of AUD\$10.00. Send to Martin Gottschall, c/- PO Box 819, Mount Ommaney, Qld 4074, Australia. Enquiries, fax +61 (0)7 3376 1780.

About the Author:

Martin Gottschall, BE, ME, PhD, FDBA, is a consulting engineer. He has Bachelor's and Master's degrees in Mechanical Engineering and is a Doctor of Philosophy. His higher awards were by research in metal deformation and high-frequency friction respectively. He has always had a keen interest in many forms of energy generation including solar thermal and solar electric.

Figure 3: Using semiconductor layers to control charge polarity of balls

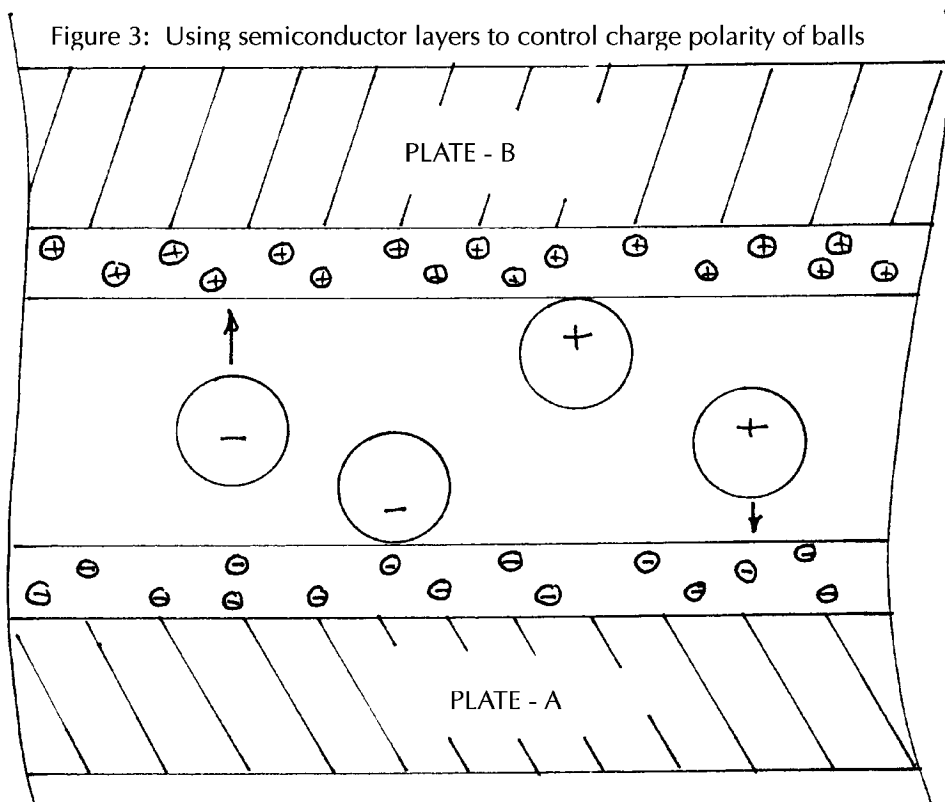

The Case for Atlantis in Antarctica

After detailed analysis of ancient maps and Plato's writings, researcher Rand Flem-Ath concludes that Antarctica is the site of the fabled lost continent of Atlantis.

Part 2

by Rand Flem-Ath © 1996

Extracted and edited from a transcript of his lecture, "Atlantis and the Earth's Shifting Crust", presented at Return to the Source Symposium, held at the University of Delaware, USA, 28 September 1996

Charles Hapgood showed that the 1513 Piri Re'is map contained at least 24 points that were accurate within a half a degree of longitude. European explorers did not match this level of accuracy until the 1770s during Captain Cook's famous voyages. The southern portion of the map seems to depict the subglacial features of Antarctica. This discovery was made by Captain Arlington Mallery, but Hapgood took up the map and made many more discoveries about it. Incidentally, Hapgood believed that this map included Atlantis. Figure 14 shows where Hapgood placed the lost continent.

Hapgood believed that Plato's "whole opposite continent" was a reference to America, and this island (Rocks of St Peter and St Paul), now beneath the Atlantic Ocean, seemed to him to be a place that matched Plato's words. But these Rocks of St Peter and St Paul can in no way be compared to a land mass high above sea-level and larger than Libya and Asia combined. Nevertheless, Hapgood's *Maps of the Ancient Sea Kings* remains the classic work on ancient cartography.

The second book that I read by Hapgood was his *Path of the Pole*, which provided a mechanism to resolve all the questions that were haunting me. Here was a theory that could explain a temperate Lesser Antarctica around Plato's date of 9,600 BC, and at the same time move me towards an understanding of a host of other scientific puzzles.

With [my wife] Rose's help, I wrote a paper incorporating my ideas and sent it to Charles Hapgood. (This letter is on our website, courtesy of Laura Lee.) Hapgood enthusiastically responded to our letter and told us that our work was "the first truly scientific exploration" of his work that had ever been done. Of course we were delighted, but also astonished.

Why had scientists ignored Hapgood's work? After all, Albert Einstein had written a glowing foreword to the first edition of Hapgood's book, *Earth's Shifting Crust*. My amazement led me to read about the history, sociology and philosophy of science, and I soon discovered that what was happening to Hapgood wasn't unusual at all. There is a vast difference between the sociology and logic of science. Logically, Hapgood's theory of Earth crust displacement should not have been ignored, but that's not the way science works. So let's consider his idea now.

Figure 15 shows the inside of the Earth: the core, the mantle and the crust. Figure 16 shows a blow-up of the area of the Earth near the surface and we have exaggerated the dimensions so that you can see the crust which rests upon a mobile layer, the asthenosphere, which in turn rests upon the solid mantle. An Earth crust displacement is a movement of the entire crust, including the ocean basins, over the asthenosphere. Now, keep in mind that the Earth's axis does not change. We still have the same tilt and the same seasons, but the relationship of the crust to the climatic zones is changed. In other words, the climatic zones are stable; it is the crust that moves.

To understand the ecological upheaval created by the Earth's shifting crust, we need to compare its position to the climatic zones both before and after the displacement.

In figure 17, we have North America's position relative to the polar zone. The top circle represents today's Arctic Circle. The bottom circle shows the Arctic Circle before the Earth's crust shifted. You'll notice that these two circles overlap on Greenland. That explains why Greenland has most of the glaciation in the northern hemisphere: the ice never got a chance to melt! The crust that used to be in the Arctic Circle includes the Great Lakes as well as Lake Winnipeg, Great Slave Lake and hundreds of thousands of other, smaller lakes. North America is a water-rich continent because it used to be



Fig. 14

trapped in the polar zone. The highlighted areas in the present Arctic Circle mark lands which were once temperate. In our book, *When The Sky Fell*, we showed how Arctic Norway, northern Alaska, Beringia and Siberia were much warmer before 9,600 BC than they are today. These lands exhibited temperate conditions where it is now much too cold to support such animals as hyenas, sabre-toothed tigers, antelope and the whole menagerie of species that we associate with East African terrain.

Before I take you to the southern hemisphere, I want to take you on a quick trip to Mars. In December 1985 I read an article in *Scientific American* which explained a series of mysteries about the surface of Mars by assuming that the planet's

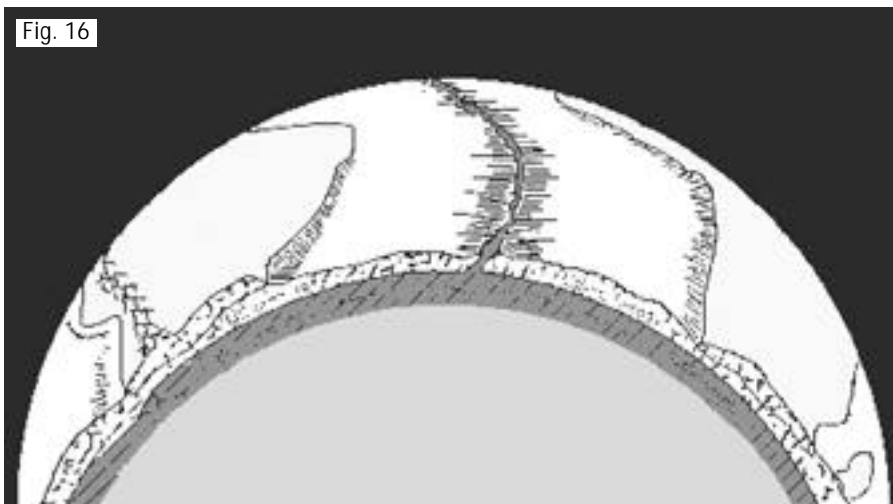

Fig. 16

Heard Island is antipodal to the Canadian province of Saskatchewan which was under ice 12,000 years ago. Both areas exhibit polar features (ice or melted ice in the form of lakes) in a temperate zone. This fits the antipodal criterion used as evidence for a crustal shift on Mars.

Greater Antarctica has so much ice because it remained inside the Antarctic Circle both before and after the Earth's crust shifted. And the area of thickest ice on Greater Antarctica is opposite to the ice-sheet on central Greenland. Lesser Antarctica is antipodal to the areas in the north, such as those in Arctic Norway, Alaska, Siberia and Beringia, which were teeming with temperate-adapted creatures.

I spoke a moment ago about the differ-

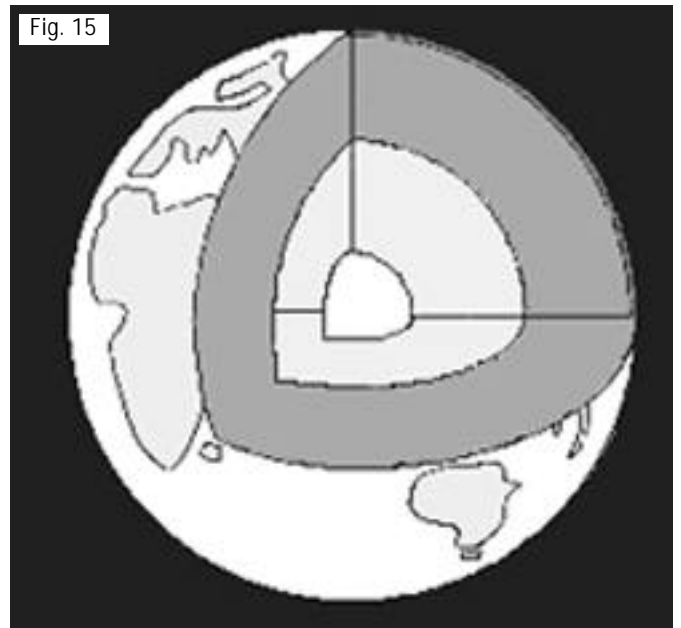

Fig. 15

whole crust had once undergone an abrupt displacement. You can imagine how excited I was! I only wished Hapgood had lived to see his ideas being applied to another planet.

To support the idea of a crustal displacement on Mars, Dr Peter Schultz of Brown University examined the planet's craters. Asteroids or comets that impact within the polar zones exhibit characteristic crater signatures because they land on thick deposits of dust and ice that accumulate only at the poles. Schultz scanned Mars in search of craters exhibiting these polar features outside the polar zones. He found two such areas, and wrote:

These zones are antipodal: they are on the opposite faces of the planet. The deposits show many of the processes and characteristics of today's poles, but they lie near the present-day equator.

Now if the "antipodal" argument is offered as evidence of crustal displacement on Mars, then we should at least consider it here on Earth. So let's look at the former position of the Earth's crust in the southern hemisphere.

In figure 18 we see the southern areas which are opposite or antipodal to those in the north. The area in the southern Indian Ocean is antipodal to the lakes that occupy most of Canada. In this area lies the still-ice-covered Heard Island. The ice-sheet on Heard Island cannot be explained by current snowfall patterns.

Fig. 17

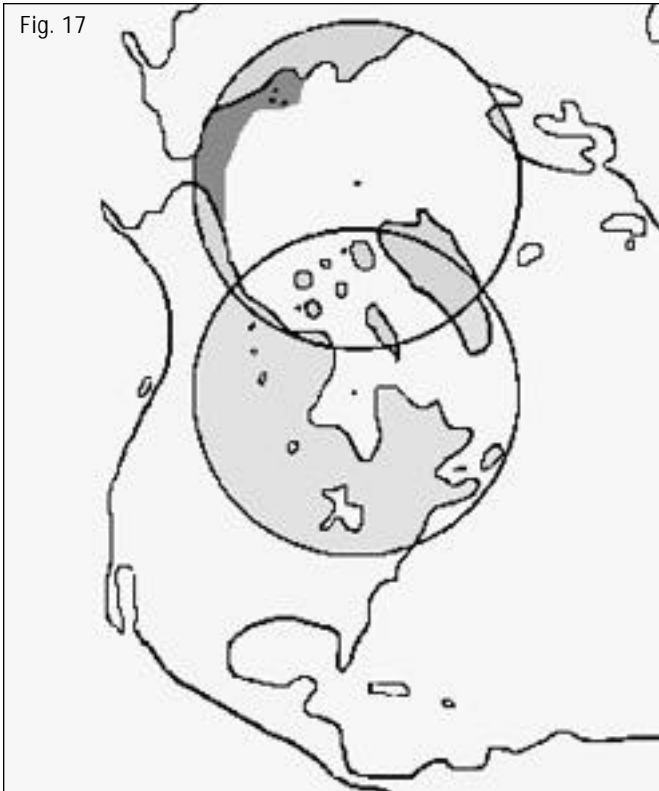

ence between the logic and sociology of science, and I can think of no better place to demonstrate this disparity than in Beringia. Every archaeologist is perfectly willing to accept there was once a subcontinent which lay between Siberia and Alaska 12,000 years ago, that was teeming with wildlife but which is now dead beneath the ocean. But anyone who entertains the idea that the same thing might have occurred on the exact opposite side of the

Fig. 18



Earth is breaking a taboo. To speak of a lost continent in the north, yet to deny one in the south, defies logic!

The lost animals of Beringia also need explanation. These animals died off because they were in a land that experienced a dramatic change in latitude. We can see this through what we call, in our book, "the Ring of Death".

The Ring of Death, depicted in figures 19 and 20, show the areas of the globe that experience the greatest latitude change (North and South America, fig. 19; Antarctica and Siberia, fig. 20). It also happens that these areas experienced a massive loss of animal life. The continents further away from the ring suffered fewer extinctions. And this pattern is consistent around the world: large mammals like mammoths and sabre-toothed tigers became extinct in Alaska, but, in Africa, huge mammals such as elephants and lions survived.

Now I'd like to return you to Ice Age America for a moment to see the world as it was before the last Earth crust displacement. In figure 21 we're looking at what we now call "the West Coast" of North America as it was 12,000 years ago when the crust was in a different position. The coast we see here could then be called "the South Coast". Let's imagine that we are on the Queen Charlotte Islands, the home of the Haida. From their perspective, what today is east was then north. For the Haida, Hudson Bay was to the north, Alaska and Beringia lay to the west, and California lay to the east. The Sun appeared to rise from California and set in Alaska.

Under these conditions, a movement from what we call "the Old World" of Siberia to "the New World" of America was simply a journey from west to east. And that made it a lot easier for the people of America to arrive thousands of years before what archaeologists are considering today. And they didn't need the ice-free corridor to bring them to America. This ice-free corridor simply mirrors the arc of the Sun's former path—the area which received the most sunshine. Its existence is to be expected.

But the ice-free corridor isn't the key to the peopling of America. The stories the first people tell of their arrival in America are quite different. Consider Mount Shasta in California. The Shasta believe that this mountain was a refuge for their

Fig. 19



Fig. 20

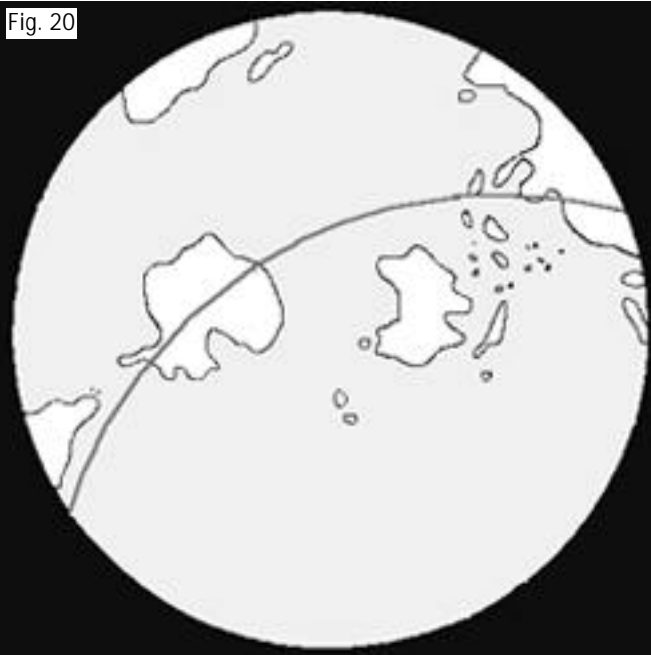

ancestors at the time of a Great Flood. The ancestors climbed the mountain to escape the rising ocean. And this is not the only mountain which saved humanity from the Flood in native American mythology.

We have two types of stories: those in which the people are already in America when the Flood comes (stories like that of the Shasta), and stories that tell of their arrival in ships that land on mountain-tops. The Okanagan of British Columbia and Washington state tell us that their ancestors fled from a sinking island in the middle of the ocean. The Haida relate how, long ago, their ancestors lived in the world's largest village. Life was carefree until the chief of the heavens decided to destroy humankind by changing the sky and bringing a worldwide flood. Survivors escaped in large canoes that took them to a new land where they landed on a mountain-top.

We believe the sky *did* appear to change dramatically before the Flood, and that's why we called our book *When The Sky Fell*. We take perfectly seriously the Haida's story of the loss of a great

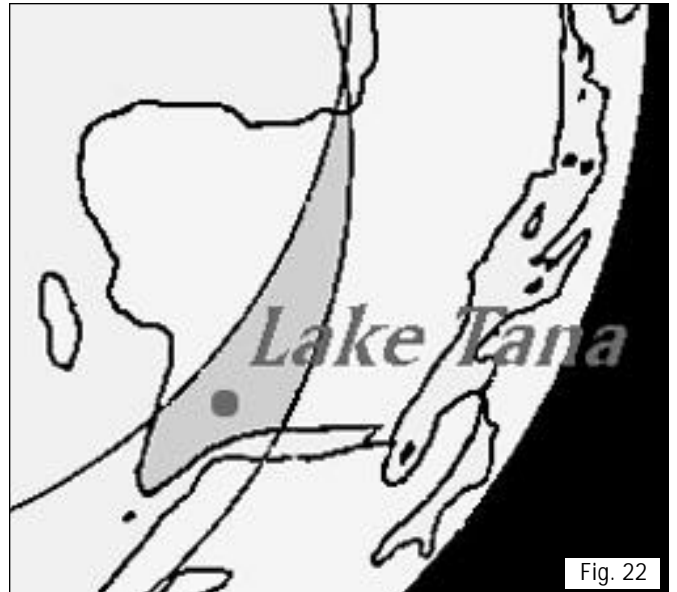

Fig. 22

city at the time of the Flood. Perhaps archaeologists should listen with a little respect to the so-called "stories" of the first people.

In 681 AD, the Japanese Emperor Temmu ordered the Guild of Narrators to record the most ancient myths. The resulting book, the *Ko-ji-ki*, told of a time when the Earth was very young, and the first land, called "Onogorojima", lay near either the North Pole or the South Pole.

I believe that Onogorojima and Atlantis are different names for Antarctica. I realise these are bold claims, but I presented evidence for the reality of an Earth crust displacement in my 1981 article in the *Anthropological Journal of Canada* (vol. 19, no. 4), a copy of which appears in the appendix of *When The Sky Fell*.

The problem archaeologists face is that the fine art of agriculture suddenly appears on different continents at approximately the same time, around 9,600 BC—that is, at the time of the destruction of Atlantis, the opening of the ice-free corridor, and the so-called "sinking" of Beringia. Now I saw the hand of the Atlantians in this development, but I couldn't use the "A-word" if I wanted to be published in a scientific journal in 1981.

And it's no different now. The idea that Antarctica might have experienced the same fate as Beringia is just not considered scientific by the powers that control scientific publishing. But I'm proud to be associated with Atlantis. I think the taboo against the word should be broken.

In the crescent or "horn" beneath Japan we find the earliest known civilisations in the world and the most important sites for agricultural origins in what is called "the Old World". I call this crescent (as defined by the current and former path of the Tropic of Cancer) "the Horn of Plenty", for it was the most favoured land after the last Earth crust displacement. There were also favourable places in the tropics which I will discuss later, but I want you to appreciate how much happened in that particular area. I call the whole area the Horn of Plenty because it was such an important area for the domestication of both plants and ani-

Fig. 21



Fig. 23

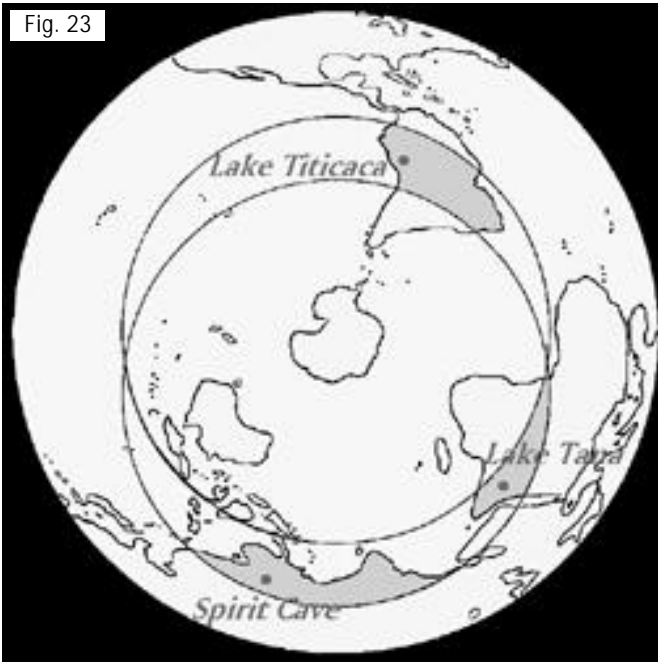

mals. The highlighted area of China in figure 23 is the widest in the Horn of Plenty and, not surprisingly, China domesticated the greatest number of crops. The Chinese have lost much of their heritage, and I believe that there are many archaeological treasures from ancient China yet to be excavated.

India domesticated the second largest number of crops. Recent investigations by David Frawley and his associates have lifted the veil over ancient India. We are beginning to see that India is much older than most of us have suspected.

The person who first attempted to push back the clock for India was called "the Beloved Leader of the People"—Bal Gangadhar Tilak, who was jailed by the British in 1897 for seditious writings.

Fig. 24



While in prison, Tilak read deeply in all the Vedic literature, and when released he wrote a book called *The Arctic Home in the Vedas*. Tilak summarised a key passage from the *Zend-Avesta*, the oldest saga of Iran:

Ahura Mazda warns Yima, the first king of men, of the approach of a dire winter, which is to destroy every living creature by covering the land with a thick sheet of ice, and advises Yima to build a Vara, or an enclosure, to preserve the seeds of every kind of animal and plant.

Yima escaped from Airyana Vaëjo (the island-paradise now at the pole) in a ship which, like Noah's Ark, survived the Flood.

Now, I believe that Tilak was right about the ice-covered island at the pole, but I think it was Antarctica, not in the Arctic.

The so-called "Fertile Crescent", where wheat, barley, goats, pigs and sheep were first domesticated, is a sub-section of the large Horn of Plenty.

Here we must mention the lost island-paradise of "Dilmun" which was recorded by the ancient Sumerians. The myth of this lost land bears an uncanny resemblance to the mythology of the Haida of British Columbia.

The ancient Sumerians tell of a time, long ago, when their ancestors lived on the island of Dilmun. Like the great village of the Haida, life on this land was carefree until the sky-god and the flood-god decided to destroy humankind by changing the sky and bringing a worldwide Flood. Survivors escaped in a large ship which took them to a new land, where they landed upon a mountain-top. Russian scientists have linked the Haida and the ancient Sumerians linguistically and it seems that they both may have shared a common heritage from Atlantis.

And now we come to Egypt. I remember the first conversation I had with [Egyptology writer] John West. He asked me where I thought the Egyptians might have been during the Flood. I replied that I thought that they might have been in the highlands of Ethiopia, which were midway between the current and former

path of the equator. This tropical oasis was a place of refuge from the rising ocean and it contained a freshwater lake, Lake Tana (figure 22). From Lake Tana, survivors of the crustal displacement could follow the Blue Nile downstream to an area near present-day Sudan where the Blue and White Nile tributaries merge to form the Nile River. There, near present-day Khartoum, emerged a culture known as the Nubia, where agriculture began around 10,000 BC—the very date that Plato's Egyptian priest said that Atlantis was destroyed.

There is another highland tropical oasis in Thailand. At Spirit Cave we find the earliest known experiments with the domestication of rice. And no doubt we'll eventually find other archaeological sites near here. On the exact opposite side of the globe lies Lake Titicaca (figure 23). Like Lake Tana, it was a high-altitude freshwater lake that ultimately came to rest at the same distance from the equator after the displacement as it was before, creating ideal conditions for survival. This area was the site of the origin of the domestication of potatoes.

So on Lake Titicaca, this high-altitude freshwater lake, are the remains of

Fig. 25



the sort of algebraic shorthand that computers understand. Indeed, such is its purity that some historians think it did not just evolve, like other languages, but was actually constructed from scratch.

Here's an artificial language, found in an area of the world that had always intrigued me because of my research into the origins of agriculture; an area that I knew would be ideal for Atlantean survivors. It would be hard to imagine how or why the Aymara would find time to invent a language. Such developments are much more likely the product of an advanced civilisation like that of Atlantis. I am convinced that the Aymara language is another holographic fragment from a lost world. This artificial language, which hasn't evolved but remains pure, may just be a key to both our past and the future.

Our belief in progress locks us into a linear notion of time. We see ourselves progressing towards the future, leaving the past behind, but this is only a modern fixation, a deep assumption about how to view time. The Aymara people of Lake Titicaca look at time another way. They treat the future as

Tiahuanaco. The Polish researcher Arthur Posnansky linked Tiahuanaco with Aztlan, the mythical "white" island homeland of the Aztecs. On the shores of Lake Titicaca live the Aymara. One Sunday morning when we were living in London I read an article in the *Times* about the Aymara language, which really woke me up. Let me quote the relevant passage:

Aymara is rigorous and simple—which means that its syntactical rules always apply, and can be written out concisely in

behind them; they consider it a hidden place that they can't see, a place at which they will inevitably arrive but need not focus on. Psychologically, the Aymara face the past.

Plato has left us a detailed map to the greatest treasure of all. We can follow his clues to find the capital city of Atlantis. His account tells us that the city lay midway on the main island facing towards the outer island. That narrows down the search considerably (figure 24). And he tells us that the city was completely surrounded by mountains. This could only be true if the islands that lie off the mainland are themselves mountainous. And this is, in fact, the case for this area of Antarctica (figure 25). So when we combine these clues we find a location marked here that is the size of Pennsylvania (figure 26).

Perhaps we might, in our lifetime, excavate the remains of an advanced civilisation beneath the Antarctic ice-sheet. Who knows what we might find in the Atlantean libraries. Who knows what we will think of their art and their science. Is there, after all, wisdom to be mined from there? Whatever we discover, I am convinced that it will change the way we view ourselves and revolutionise the way we see time.

The present need not be the only key to understanding time. It is not too late for us to listen to the wisdom of the ancients. The past can enrich and even guide our present. And the past might even turn out to be the key to our future.

About the Speaker:

Rand Flem-Ath is co-author (with Rose Flem-Ath) of *When The Sky Fell: In Search of Atlantis*, published in 1995 by Stoddart Publishing (Ontario), Weidenfeld & Nicolson (London) and St Martin's Press (New York) (see review in NEXUS 3/01).

Fig. 26





HUGE UFO EMERGES FROM SEA NEAR OIL RIG

The following report was posted on the Internet by Ben Field of *UFO Updates*, Toronto, Canada, on 14 January 1998, and was reprinted in the April 1998 issue of *The Star Beacon*.

Permission to publish report: Yes
 Name: Jeremy Clark Packer
 Age: 32
 Occupation: Engineer
 Date of sighting: Monday, (?)
 December 1997
 Time of sighting: 8:00 am
 Location of sighting: Corpus Christi, Texas
 Description of area: Oil platform, 30 miles from shore off Gulf of Mexico. No land masses, no clouds, heavy wind, several liners. 500-manned rig.
 Other witnesses? Yes
 Relationship of witnesses: Co-workers
 The UFO was sighted in or near water. The UFO was sighted in or near an air route. The height of the UFO from the ground was about 280-300 feet above sea.
 Noise information heard during the sighting: Rumbling sound for most of the sighting. Our watches stopped working!

The UFO was sighted for 30 minutes. Photographic record? Yes
 Did you experience any effects, i.e., loss of time? Yes. All our watches showed 30 minutes late.
 Weather and conditions: Windy weather, cold. Daylight.

Jeremy Packer's description of this UFO sighting follows:

I had just woken up for our daily routine on the rig. Our sleeping quarters were below sea level, so we all had to trudge [sic.] up to the main core housing to start work. It was about 7.58 to 8.00.

My watch stopped ticking at 7.58, but I

don't know if my time was right. Everyone else's watch stopped ticking as well, with various times.

As I and about 20 other men neared our stations to perform the daily greasing and releasing routine, we stopped cold in our tracks. The bore that drills the hole into the ocean floor was bent like a toothpick into a V shape.

We looked at the underwater cameras to recheck what our eyes saw and we couldn't believe.

First off, this bore is 140.65 feet thick, made of solid steel. Nothing can bend it, let alone something on the ocean floor—and it wasn't even on the ocean floor! It



THE TWILIGHT ZONE

was just right below the surface of the water, about 200 feet—the amount of pressure it would take would be equal to the Sun's force.

We were dumbfounded. Then we got scared! Everyone started hearing a rumbling noise and we knew it wasn't the engines running the platform bore. Everything shuts off when something goes wrong.

Out of the west we saw what looked to be about 25 to 30 helicopters on manoeuvres—not an uncommon sight. What was uncommon was that the rig commander came up and told us he had no alerts to any military manoeuvres from the Coast Guard that day. They usually alert us whenever they do these things in our vicinity. Another peculiar thing was that the helicopters made no sounds. None. Zip!

Then we all ran to the west side of the platform—about 250 of us, in all. The others were below sleeping; they have the night shift. Then we saw something that totally changed us! All of the helicopters stopped in mid-air, and something large—*very large*—surfaced beneath them.

It was a *huge* metal object, about the size of our platform! It just came straight out of the water and straight into the air! It hovered over the helicopters for about two minutes—enough for us to use the telescopes to check it out!

It was as large as about two football

fields, concave underneath, with four large bulbous domes in the concave part of the bottom of it.

It turned on its side and we saw that it looked like a huge flying cigar which was tapered at both ends. On the top of the thing was another concave indent that had lights circling within in—every colour you could possibly imagine! It was beautiful! We heard the soft rumbling all throughout the sighting.

Then something amazing happened as we stood there in disbelief. Like someone turning off a light switch, it was gone. One second we were all looking through binoculars, telescopes and through just our eyes. Hell, it was close enough you didn't need the devices! Then it was gone. I would say, in as fast as you could blink, or a light switch would turn on and off a light, it was gone.

The helicopters headed our way and passed us overhead, again never making a sound. We could see that they had absolutely no markings. Familiar with the stuff the military does around here, we knew they weren't military craft. Some looked like they were stainless steel, almost invisible; some were jet black. I counted 22. My best friend counted 28. Everyone had a different amount.

We all also noticed that our watches were about 30 minutes later than what the time actually was when we got back to the

mainland. We were sent on temporary leave by our bosses for what we reported, so that they could fix/repair/replace the bore on the rig.

I'm back at work now, but I still look out at the ocean every chance I get!
(Source: The Star Beacon newsletter, April 1998; Earth Star Publications, PO Box 117, Paonia, CO 81428-0117; web site, www.galaxycorp.com/starbeacon. Subscription, 12 issues: US\$20 in US; US\$28 overseas.)

CONTROVERSY CONTINUES OVER ARTIFICIAL LANDFORMS ON MARS

As promised, the Mars Global Surveyor (MGS) once again turned its high-resolution camera towards the controversial landforms at Cydonia on 23 April and delivered a clear, well-lit image of the "Main Pyramid" and "City Square", two features of considerable interest to Cydonia researchers.

However, the MGS camera failed to capture the "Fortress" which lies slightly northeast of the main pyramid. After the "Face", the Fortress was the object of greatest interest to those who believe the landforms at Cydonia may be artificially constructed.

Having now fulfilled a promise to make three imaging attempts over Cydonia during the month of April, NASA has no further plans to photograph the area until 1999. But NASA chief administrator Daniel Goldin told CNN science correspondent John Holliman that the MGS would, in due course, send back more pictures of the Cydonia region "until everyone is satisfied".

Depending upon whom one asks, the new Cydonia images show nothing but obviously natural geological features; or they offer strong corroborating evidence of artificial structures; or they prove nothing one way or another.

Professor Stanley V. McDaniel of the Society for Planetary SETI Research, one of the strongest proponents of possible artificial structures on Mars, indicated in an essay posted on his website (www.mcdanielreport.com/) that the latest image of the City shows features that "appear consistent with a natural geological interpretation".

Professor McDaniel pointed out that the four small mounds comprising the City Square, which in the 1976 Viking photo

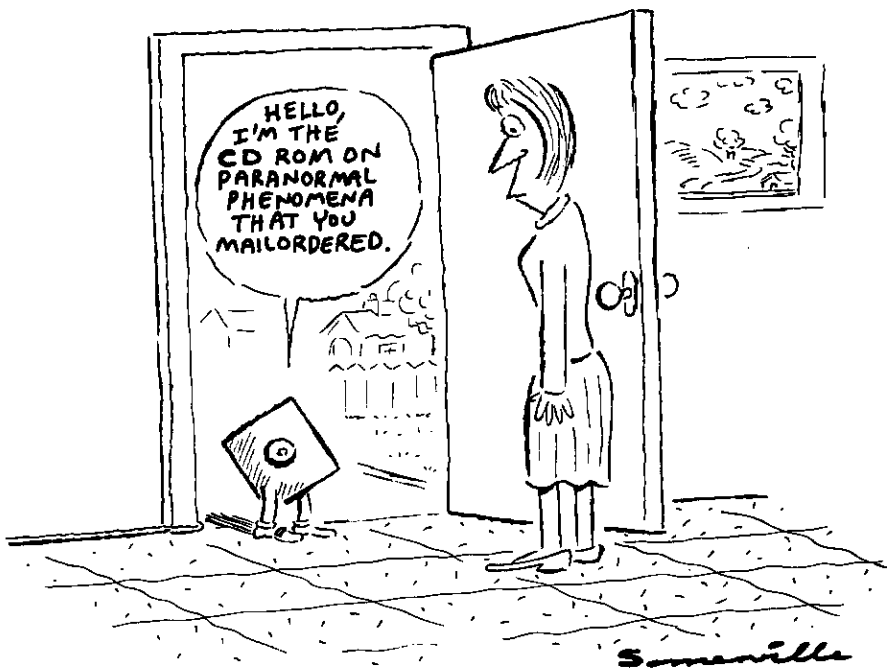

appear highly regular, are seen in the much clearer MGS image to be non-uniform in shape and non-symmetrical in placement.

Similarly, the large Main Pyramid has the appearance of a small mountain, not a large building.

Many voices echoed this assessment. Typical was a statement issued by David Watanabe of exoScience UFO (exosci.com/ufo/), who wrote: "I think all can agree that the images returned by MGS show no signs of artificiality. These formations are, as far as we can tell through visual observation, quite natural."

McDaniel, however, noted several odd, smaller features on the Pyramid that seem more angular and symmetrical than expected of natural formations. "There is a peculiar feature at the NE corner of the [Pyramid] that should demand geological investigation. This is a cluster of two or perhaps three nearly rectangular outlines that may be enclosures of some sort," McDaniel stated.

Another nearby object has the distinct appearance of a nearly perfect square inside a very circular crater.

Meanwhile, other Cydonia researchers were not at all ready to admit disappointment. Richard Hoagland, who had earlier accused NASA of withholding data when the space agency released the first MGS image of the Face, now says that the structures in the third image offer impressive evidence of artificiality.

"Early enhancement of MGS image 25803 reveals multi-layered 'room-sized' cells underneath the long-eroded surface of the 'Main Pyramid,'" Hoagland states at his Internet website (enterprisemission.com/images/mars). Furthermore, he theorises that "The latest MGS image reveals the center of the Cydonia complex—the 'City Square'—to be a series of four high-tech, glass-like pyramids...heavily in ruins".

While no other Cydonia researcher seems ready to join Hoagland in this degree of enthusiastic speculation on the City features, physicist Dr Tom Van Flandern issued a statement last week in which he stated that the new MGS image of the Face—disappointing to many—has convinced him beyond reasonable doubt that that structure is artificial.

Thus, the debate goes on. Certainly the MGS images did not deliver the kind of evidence that Cydonia researchers had hoped for and that many had expected. On the other hand, neither did those images

entirely dismiss the theory of artificial structures at Cydonia.

Indeed, further scrutiny may tend to bolster the hopes of the more cautious researchers such as Professor Stanley McDaniel and Dr Mark Carlotto. That, and whatever new evidence may come in 1999, remains to be seen.

(Source: *CNI News*, vol. 4, no. 5, Part 1, 1 May 1998; e-mail, CNINews1@aol.com)

VATICAN INTEREST IN EXTRATERRESTRIAL CONTACT

Monsignor Corrado Balducci, a Vatican theologian and insider close to the Pope, has gone on Italian national television five times in recent months to proclaim that extraterrestrial contact is a real phenomenon.

The prelate announced that the Vatican is receiving much information about extraterrestrials and their contacts with humans from its nuncios (papal ambassadors) in various countries such as Chile, Mexico and Venezuela.

Monsignor Balducci said that he is on a Vatican commission looking into extraterrestrial encounters and how to cope with the emerging general awareness of the reality of extraterrestrial contact.

Balducci provided the Catholic Church's analysis of extraterrestrials, emphasising that extraterrestrial encounters "are *not* demonic, they are *not* due to psychological impairment, they are *not* a case of entity attachment, but these encounters deserve to be studied carefully".

Since Monsignor Balducci is a Vatican expert exorcist, and since

the Catholic Church has historically demonised many new phenomena that were poorly understood, his proclaiming the Vatican's non-censure of these encounters is all the more remarkable.

Balducci revealed to a visiting American clinical professional from the Academy of Clinical Close Encounter Therapists that the Vatican is closely following this phenomenon.

Parallel information from MJ-12 scientist Dr Michael Wolf suggests that the Vatican is concerned that it will have a major doctrinal updating situation on its hands when extraterrestrial contact becomes authoritatively announced by world governments over the next several years.

(Source: *Forwarded by Richard Boylan, PhD, LLC, 2826 O Street, Suite 2, Sacramento, CA 95816, USA; telephone (916) 455 0120; e-mail, rich.boylan@24stex.com*)



THE CONTROVERSY OVER 'THE MYSTERIOUS ORIGINS OF MAN'

**Archaeological
evidence for
humanity having an
extremely ancient
history on this
planet has been
condemned as
being dangerous to
established
scientific belief.**

by Michael A. Cremo © 1997

Research Associate in History and
Philosophy of Science
Bhaktivedanta Institute
9701 Venice Blvd #5
Los Angeles, CA 90034, USA
Telephone: (310) 837 5283
Fax: (310) 837 1056
E-mail: mcremo@compuserve.com

The following is the text of a talk given by Michael Cremo at the Ancient Astronaut Society World Conference in Orlando, Florida, USA, on 8 August 1997.

In February 1996 my book, *Forbidden Archeology*, was featured in an NBC television special called *The Mysterious Origins of Man*. It was produced and directed by Bill Cote and his associates. This television program was seen by tens of millions of people in the United States, and it inspired an extremely emotional, negative response from the scientific world which was shocked by the program's documentation of evidence for extreme human antiquity.

The nature of this response says a lot about mainstream science. We are normally taught that scientists are not attached to any particular theory and are always ready to change their ideas when confronted with new evidence. But the reaction of mainstream science to *The Mysterious Origins of Man* demonstrates this is not always true.

Before analysing the scientific responses to *The Mysterious Origins of Man*, I want to place all of this in context, showing the relationship of the show's archaeological evidence to the ancient astronaut hypothesis.

According to standard scientific ideas, humans like ourselves appeared fairly recently on this planet, about 100,000 years ago. Before that, there would have been only more ape-like human ancestors which came into existence four to five million years ago. The first primitive apes and monkeys would have come into existence about 40 or 50 million years ago, and life itself arose two or three billion years ago. We are told that all of the physical evidence ever discovered by scientists supports this scenario.

But in my book, *Forbidden Archeology* (co-authored with Richard Thompson), I document hundreds of cases showing that human beings like ourselves have existed on this planet for two or three billion years.

This is consistent with the historical accounts found in the ancient Sanskrit writings of India. As a member of the Bhaktivedanta Institute (the science studies branch of the International Society for Krishna Consciousness), I have carefully studied these texts for over 20 years and have found they provide many accurate clues to the true story of human origins and antiquity.

I will not give a detailed account of the archaeological evidence presented in *Forbidden Archeology*. I talked about that at the last world conference in Berne, Switzerland. Today I want to focus on how this evidence relates to the ancient astronaut hypothesis.

If, as the evidence indicates, human beings have existed on this planet for over two billion years, this rules out any Darwinian evolutionary explanation for human origins that is current today. In my opinion, this means we have to look toward an extraterrestrial explanation for our presence here on Earth.

The ancient Sanskrit writings of India speak not only about an ancient human presence on this planet. They also speak about humanoid creatures from other parts of the universe who travelled in spacecraft known as *vimana*. In the *Bhagavata Purana*, also known as the *Shrimad Bhagavatam*, we are told that once Shiva and Parvati were sitting in an assembly of sages when King Chitraketu flew overhead in his *vimana*, on a voyage from another planet. It is interesting to note that Shiva and his consort Parvati are considered gods, whereas King Chitraketu, who was engaged in interplanetary travel in his *vimana*, was a human, originally from Earth. In other words, the ancient Sanskrit texts make a clear distinction between space-travelling humans and gods.

This is relevant to the ancient astronaut hypothesis, which in one form suggests that all accounts of gods in ancient writings represent the attempts of ancient peoples to translate

the experience of seeing actual humanoid space visitors into mythical supernatural beings (gods).

We should, however, be careful that we do not become victims of a false dichotomy. When confronted with two possibilities, it is tempting to think that either 'this' must be true or 'that' may be true. In other words, either there were ancient astronauts or there were gods. But both may be true. Ancient peoples may have encountered both astronauts (humans using advanced technology for interplanetary travel) and gods (supernatural beings, by which I mean beings from regions of nature not normally accessible to Earth humans). That is what the ancient Sanskrit writings suggest to us.

So we should not become 'cargo cultists' in reverse. Earlier in this century, when Pacific tribal people encountered Westerners coming down from the sky in airplanes full of valuable goods they began to build systems of worship around the experience, translating the real technological into the mythical supernatural. This has probably occurred in the past as well. But we should be careful not to automatically translate all accounts of the supernatural in ancient writings into something that fits our present technological experience. We should remain open to the possibility that in ancient times the Earth was visited by both astronauts and gods.

According to the ancient Sanskrit writings of India, humans on this planet originated by a process of descent with modification. This process thus has something in common with Darwinism, which also posits a process of descent with modification. But the process described in the ancient Sanskrit writings is intelligently guided.

The ancient Sanskrit writings tell not only of ancient human civilisations and space-travelling humans but also of some very interesting genetic manipulations and variations on the normal

reproductive processes. Such things as test tube babies, cloning and genetic engineering are not new. They were there in ancient times, and the action was not confined to this Earth: it was interplanetary. Two years from now, at the next world conference in Cologne, Germany, I will speak to you about this. This process of guided reproductive modification is also the subject of my next book, which I am calling *Human Devolution*.

What this all adds up to is that Darwinian explanations of human origins are not adequate. The very existence of ancient astronauts poses a strong challenge to Darwinian concepts of human origins. The ancient astronaut hypothesis tells us that humans on this planet were visited in the distant past by humanoid beings from other planets. Let us carefully consider the implications of this.

The very existence of ancient astronauts poses a strong challenge to Darwinian concepts of human origins.

According to Darwinism, the structure of physical bodies is encoded in the DNA in the body's cells. To change the bodily form, the DNA must be changed. These changes are said to be random, resulting from copying errors, mutations and recombination. To go from the first one-celled living things to humans like ourselves required, we are told, millions of random genetic changes over the course of more than two billion years. This has led leading evolutionists such as Stephen J. Gould to say that if we were to 'run the tape again' the evolutionary process would

probably not give us upright-walking humans, apemen or apes. So it is extremely unlikely that humanlike creatures could have evolved in Darwinian fashion both on this planet and somewhere else in the universe. In other words, the very fact that there are humanoid creatures from other parts of the universe is a good argument against current Darwinian explanations for the origin of humans on this planet.

Having established the connection of the evidence reported in *The Mysterious Origins of Man* with the ancient astronaut hypothesis, we can now proceed to examine the heated scientific responses to this program. These responses amount to a kind of 'knowledge filtration'.

In my book, *Forbidden Archeology*, I described not only evidence for extreme human antiquity but also the processes by which dominant groups in science exclude this evidence from scientific discussion and public attention. These processes, which I collectively refer to as the "knowledge filter", are a powerful factor in keeping certain kinds of evidence relatively unknown.

In the case of *The Mysterious Origins of Man*, the knowledge filtration process began to operate even as the show was being filmed. I suggested to the producers that they film stone artefacts discovered in Californian gold-mines during the 19th century. Geological evidence indicates that these objects are about 50 million years old. The artefacts are stored at the Phoebe Hearst Natural History Museum at the University of California in Berkeley. The responses from the museum officials are interesting.

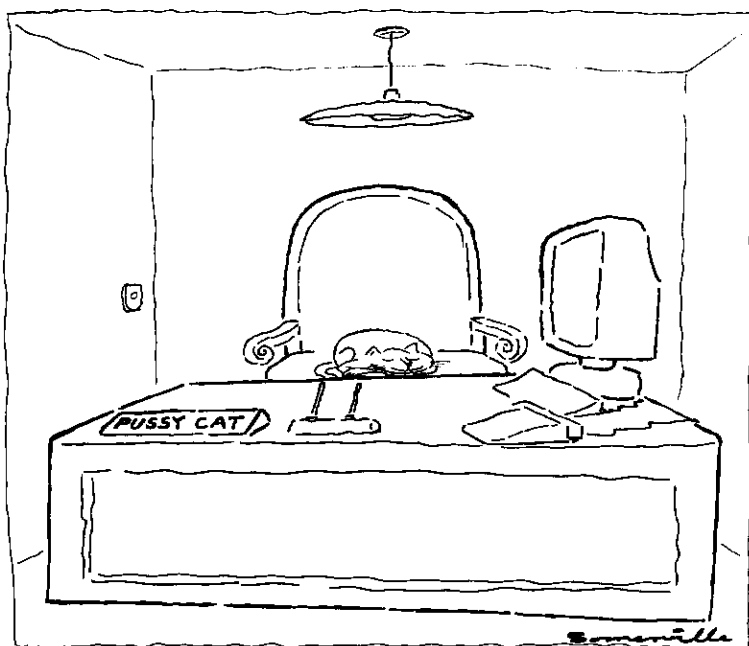

"At first we were told they could not make the time," wrote producer Bill Cote in a letter to me (26 August 1996). "We countered, saying we had plenty of time and could wait three or four months." Museum officials responded with a letter claiming they had a shortage of staff and funds. The producers said they would pay all the costs involved in bringing the artefacts out of storage for filming, including overtime pay for the workers. The museum refused this offer. The producers continued to seek permission through various channels. "We patiently went all the way to the head of publicity for the University," explained Bill Cote in his letter, "but it seems the museum director has final say, and she said no."

"A similar situation occurred when we tried to obtain permission to film the pyramid complex at Teotihuacan, near Mexico City," wrote Bill Cote. "We approached, through proper channels, the director of the site. He wanted us to promise that we would make no mention of UFOs or spacemen building the pyramid. I thought this was odd, but since that was not our intention, I replied in all honesty that we would not imply this. Then he demanded a copy of our full script. We had not yet written the scene and told him so, but he insisted.

"We spent a few hours and drafted a modest version which included the theory of Hugh Harleston Jr, a respected researcher, that the slope angle of one of the facets of the Pyramid of the Sun was aligned to the same degree of latitude as the location of the pyramid itself in the northern hemisphere (an easily verifiable fact). In effect, the sunrise over the pyramid on the vernal equinox would cast a shadow over this facet in an instant, thus making the whole pyramid a sort of giant clock. We were interested in demonstrating the advanced knowledge of the ancients. But we were denied permission to bring our cameras into the site or even to fly over in a helicopter, despite the fact that we were willing to pay all the appropriate fees, had gone through both archeological channels and the Mexican film authority... The good old boys' network continues to hold a powerful control over information that threatens to upset the established view."

The knowledge filtration process, which began with the filming of *The Mysterious Origins of Man*, continued with even greater intensity when the program was shown to the public. The anti-Darwin message of the show was the main reason why scientists reacted so angrily. To my knowledge, the broadcast of *The Mysterious Origins of Man* by NBC in February of 1996 was the first time in history that a major American television network had aired a program challenging Darwinian explanations of human origins. This apparently caught the scientific community by surprise.

The surprise is evident in the following excerpt from an article in *Science*, a journal published for scientists by the American Association for the Advancement of Science (8 March 1996, p. 1357):

"The claims of creationists—the young age of Earth, that fossils put the lie to the theory of evolution—routinely send biologists into fits. But those fits pale before the indignation spilling out, mostly over the Internet, since Sunday evening, 25 February, when a major US television network ran a 'special' suggesting that

humans coexisted with the dinosaurs, and that the scientific establishment was suppressing the evidence."

Here are some samples of some of the 'Internet indignation' that poured out from the scientific community, taken from a report released by B.C. Video on 4 March 1996:

"I think you should apologize publicly for this show. It was appalling... Frankly, you are either morons or liars..." (D.L., Colorado. edu)

"...the non-scientific public watching this drivel may be inclined to actually believe it and to vote for politicians who also believe it." (J.K., New Mexico State University)

"It's all a bunch of hooley, and my recommendation is to stay away." (B.D., Yale University)

"I recommend people write NBC and protest the presentation of this show as a documentary." (AD, University of Texas at Austin)

"You should be banned from the airwaves." (J.J., ALCI)

Why exactly did scientists react with such fury to *The Mysterious Origins of Man*? One reason is control over the minds of students.

The National Center for Science Education is dedicated to keeping Darwinism a central concept in America's schools. In the same *Science* article cited above, the president of the National

Center for Science Education complained that the phones in the headquarters of his organisation were constantly ringing with calls from science teachers who had difficulty answering questions from students who had seen *The Mysterious Origins of Man*.

Another concern that I noted in my study of hundreds of Internet messages was the fear among scientists that programs such as *The Mysterious Origins of Man* might eventually result in public pressure to decrease government funding of certain kinds of scientific research

supporting Darwinism. This concern is reflected in the message above from J.K.

The reactions to *The Mysterious Origins of Man* extended by individual expressions of negative opinions to the producers. Dr Jim Foley organised a letter campaign directed at the executives of NBC and the sponsors of the program, including Coca-Cola, McDonalds, Olive Garden, Toyota, Chevron, Kellogg's, J.C. Penney, Honda, Wendy's, General Motors, LensCrafters, Folger's Coffee, and M&M's Candy.

A lot of the Internet messages among scientists were also heavily critical of *Forbidden Archeology*, which was featured in the show. But one participant in the Internet debate (D.T. Miller, 1 April 1996) noted: "It looks like most of the detractors haven't read the book. Could someone please explain to me how anyone can pose a valid criticism of a book they haven't read? (Yes, I've read the book.)"

Some of the Internet discussion regarding *Forbidden Archeology* was related to the mysterious metallic, grooved spheres found by miners in South Africa in mineral deposits over two billion years old. In the absence of any good explanation of how such objects could have formed naturally, the possibility remains open that they are the product of some kind of human intelligence. Some of the spheres were shown on the NBC television program.

On the Internet, scientists claimed they were natural "concre-

To my knowledge, the broadcast of *The Mysterious Origins of Man* by NBC in February of 1996 was the first time in history that a major American television network had aired a program challenging Darwinian explanations of human origins.

tions" and that such things are very common, grooves and all. But when I challenged them to send me pictures or specimens of round metallic concretions with grooves running around their equators, none could do it.

If the scientific community in America was outraged when the program was first shown, you can imagine their reaction when they saw the following headlines from an Internet press release from NBC, dated 29 May 1996: "Controversy Surrounds *The Mysterious Origins of Man*... University Profs Want Special Banned from the Airwaves... Program that Dares to Challenge Accepted Beliefs about Pre-Historic Man will be Rebroadcast June 8 on NBC". Amazingly, NBC was using the objections of the scientists to promote another broadcast of the show!

The text of the press release stated: "NBC's *The Mysterious Origins of Man* sparked heated controversy within the academic community when originally broadcast February 25, 1996, and will be rebroadcast on Saturday, June 8 (8-9 pm ET). Professors of science and anthropology from some of the nation's most prestigious colleges and universities voiced strong opinions about some of the theories in the special, which challenged long-accepted beliefs about man's beginnings. The program presented startling evidence suggesting that man may have made the climb from Stone Age to civilization more than once; that present-day man is just the latest in this cycle, and that Darwin's Theory of Evolution has serious flaws."

Producer Bill Cote was quoted in the NBC press release as follows: "Our goal was simply to present the public with evidence which suggests an alternative view to some of our most accepted theories. We questioned fundamental issues that they [some scientists] felt should not be questioned. The bottom line is, the world is bigger than scientists can explain, and some of them want us to believe they can explain everything.

"We expected some controversy when we produced this show," Cote continued, "but no one was prepared for the enormous cry of outrage from members of the scientific community. While many viewers, including some scientists, praised the production as a great accomplishment and contributing to public education, many scientists expressed outrage and criticism."

Dr Jere H. Lipps, a palaeontologist at the University of California at Berkeley, wrote by e-mail to producer Bill Cote on 30 May 1996 (sending copies to various scientific discussion groups on the Internet): "I appreciate the advance notice of your press release about the reshowing of *The Mysterious Origins of Man*. Can you please provide me a list of the news organizations you sent your release to? As you expected, I am appalled that you and NBC would once again represent that program as the way science in America is done. It does not do you, NBC or the sponsors any honor whatsoever. It indicates to scientists a large degree of ignorance about how science works. You seem to think that scientists object to the theories presented. Not in most cases, because everything in the program has been dealt with by legitimate science already. You misrepresent the process of science—that is quite a different and detrimental thing. I can always straighten out bad ideas with my students, but trying to teach them an intelligent way to live their lives in this scientific society is very difficult when TV promotes a fraudulent view of how science works.

"I am amazed that NBC [will] show this program again as science, when a proper scientific presentation of the same issues would be both beneficial and entertaining to its viewers. As [you are] its writer and director, I can appreciate your desire to use our objections to promote it once again. It is, however, a pathetic way to make a buck, when honesty is so much better and [more] profitable."

As far as honesty is concerned, I hope no one will be deceived that it was anything other than the anti-Darwinian message of *The Mysterious Origins of Man* that provoked such intense reactions from Lipps and others. They *did* object to the theories presented. Also, the show provided a very good description of how science (the fundamentalist Darwinian part of it, anyway) really does work in practice. Fundamentalist Darwinians do unfairly try to prevent serious discussion of controversial evidence.

On the same day he sent his letter to Bill Cote, Lipps made this general appeal to scientists: "NBC is now proposing to reshow their scientific travesty, *The Mysterious Origins of Man*, using the objections of the scientific community as a selling point. This is a major disservice to the general public and misrepresentation of the majority of the scientists' objections... If you are worried

about science in America, tell your local NBC station, NBC and its various sponsors that you object to the portrayal of this program as science. America must get smart and we can make a difference."

Others proposed boycotts, as shown in this Internet message posted to Internet discussion groups for archaeologists and anthropologists by C. Wood on 31 May 1996: "Anybody know who the sponsors are? I would like to get an early start boycotting them. There's always the

offchance that some of them will pull their sponsorship." Still others proposed pressuring the executives of General Electric, the company that owns NBC.

Ten or 20 years ago, the campaign of intimidation waged by Lipps and other fundamentalist Darwinians in the scientific community would have been sufficient to keep NBC from airing the program again or force NBC to let a fundamentalist Darwinian commentator dictate to the public how they should see the show. That NBC had the courage to stand up to the intimidation and the audacity to use the protests from the fundamentalist Darwinians to promote the rebroadcast of the unchanged original show to the public is a refreshing sign that intellectual freedom is alive and well in America.

But representatives of orthodox science did not see things that way. They thought NBC should be severely punished for daring to air the show a second time.

On 17 June 1996, Dr Allison R. Palmer, president of the Institute for Cambrian Studies, wrote to the Federal Communications Commission, the government agency that grants licences to television broadcasting companies: "This e-mail is a request for the FCC to investigate and, I hope, seriously censure the National Broadcasting Company for crassly commercial, irresponsible journalism that seriously violates the trust the public should have in materials that are touted as credible by a major net-

"The program presented startling evidence suggesting that man may have made the climb from Stone Age to civilization more than once; that present-day man is just the latest in this cycle, and that Darwin's Theory of Evolution has serious flaws."

Continued on page 88



REVIEWS

BOOKS

Reviewed by Ruth Parnell

HIDDEN AGENDAS

by John Pilger

Publisher: Vintage, UK, 1998

ISBN: 0-099-74151-2 (687pp p/b)

Price: AUD\$19.95; NZD\$24.95;

STG£10.50 inc. p&h; NLGf32,90;

CAN\$21.95

Distributors: **Aust/NZ/UK/Can**— Random House; **UK/Europe**— NEXUS offices.

John Pilger is a rare journalist and filmmaker who is almost as controversial as his subject matter. His latest *tour de force*, *Hidden Agendas*, is titled as such because he asserts it is not enough for journalists to be mere messengers: they need to understand the hidden agendas behind the messages and the myths surrounding them.

This "information age", he explains, is one of the great myths of modern times. With the limits imposed by the mainstream media we cannot hope to get a truthful picture of what's really going on in our world. Thus, *Hidden Agendas* is devoted to "slow news"—the important world events which are unreported and under-reported, which are misrepresented, sanitised and trivialised by propaganda and censorship.

Pilger covers a great deal of ground (much of which has been bombed, napalmed and nuked). He looks behind the scenes of UN "peace-keeping" missions and the UK armaments industry, and at the role of the IMF and World Bank in the globalisation agenda. He considers the post-Gulf War fate of Iraqi civilians, the plight of Burmese dissidents, the fight of the Liverpool dockers and life in "new" Britain, South Africa and Vietnam.

His chapter dealing with the East Timorese betrayal by both Liberal and Labor governments in Australia is indicative of how economic, political and military interests can so cynically dismiss and suppress basic human rights. Anyone concerned with the social injustices of the world will despair at Pilger's revelations, but will be inspired by those brave enough to resist oppression.

MAD COW USA: Could the Nightmare Happen Here?

by Sheldon Rampton and John Stauber

Publisher: Common Courage, USA, 1997

ISBN: 1-56751-111-2 (246pp h/c)

Price: AUD\$50.00; NLGf54.90; USD\$25

+ \$5 p&h; o/s airmail, contact publisher

Distributors: **Aust**—Cameron Books, ph

(02) 4758 7676, fax (02) 4758 9047;

Europe—NEXUS office; **USA**—Common

Courage Press, PO Box 702, Monroe, ME

04951, ph (207) 525 0900, 1800 497

3207 (toll-free), fax (207) 525 3068.

US FDA regulations passed in June 1997 to ban the feeding of rendered sheep and cattle to ruminants have come nearly a decade too late, argue the authors of *Mad Cow USA*. Apart from being difficult to enforce, these regulations are inadequate: they fail to prohibit cannibalistic feeding practices in other animals consumed by humans, e.g., pigs and chickens, and they don't address the problem of BSE-contaminated protein getting into anything from cosmetics and drugs to garden fertilisers.

Authors Sheldon Rampton and John Stauber edit *PR Watch*, published by the Center for Media & Democracy, and they have an informed perspective on lobbying by industry groups and food authorities to

minimise the impact of regulations on their practices. Apart from the media downplaying the BSE/CJD threat, PR and legal firms counter valid consumer concerns by denigrating scientists and activists who have argued for years for the implementation of complete preventive measures in the US.

Rampton and Stauber detail the scientific discoveries behind BSE, CJD, kuru, scrapie and other transmissible spongiform diseases and document the trans-Atlantic political, social and economic background of BSE and its link with CJD. Indeed, TSEs are not unknown in the US, and news of the 1979 discovery of a TSE-type disease in pigs is disturbing in terms of the new FDA regulations. US authorities and the American people would be mad to ignore these warnings.



REVIEWS



BOOKS

THE EARTH'S SHIFTING AXIS: Clues to Nature's Most Perplexing Mysteries by Mac B. Strain

Publisher: ATL Press, Inc., USA, 1997

ISBN: 1-882360-30-3 (270pp h/c);

1-882360-31-1 (s/c)

Price: USD\$42.95, USD\$52.50 (outside USA) (h/c); USD\$19.95, USD\$29.50 (outside USA) (s/c); NLGf43,90

Distributor: **USA**—ATL Press, Inc., PO Box 4563 T Station, Shrewsbury, MA 01545, ph (508) 898 2290, fax (508) 898 2063; **Europe**—NEXUS office.

Science has yet to explain so many of the geological events that have shaped the surface of our planet. We still don't know for sure what caused the so-called ice ages, or continental lands high above sea level to be invaded by ocean, or miles-thick sedimentary beds to be deposited, or mammoths to be snap-frozen. One grossly overlooked factor in our planet's evolution, argues retired engineer/geologist Mac Strain, is the periodic shifting of the Earth's axis.

In his book, *The Earth's Shifting Axis*, Strain presents his Dynamic Axis Theory which posits that weight shifts on the planet change the centrifugal forces at the equator, causing the axis to wobble and seek a new rotational balance. As the Earth's equatorial diameter is approx. 27 miles greater than the polar diameter, and as the North Pole wanders, we have a recipe for "axis surge".

While he is not the first to point to the effect of axis shift, Strain has gone to great lengths to back up his theory with supporting mathematics and geophysical evidence.

He argues that "magma seas" respond to changes in these same centrifugal forces by causing crustal dynamics such as earthquakes and volcanic eruptions. He suggests that his theory may also explain both latitude and elevation changes that affect regional climates—and much more.

Mac Strain by no means claims to have all the answers, but he does pose thought-provoking questions that he hopes other scientists and engineers will continue to research.

GODS OF EDEN

by Andrew Collins

Publisher: Headline, UK, 1998

ISBN: 0-7472-2108-1 (372pp h/c)

0-7472-7504-1 (s/c)

Price: AUD\$49.95 (h/c), \$29.95 (s/c); NZD\$69.95 (h/c); STG£21.00 (h/c) inc. p&h; NLGf68,90

Distributors: **Aust/NZ/UK**—Hodder Headline; **UK/Europe**—NEXUS offices.

This second book from Andrew Collins (author of *From The Ashes of Angels*) is an absorbing read that raises more questions than it answers. Collins argues that "Elder Gods" sparked the birth of civilisation in the upper Euphrates Valley around the 10th millennium BC. But prior to that they were based in Egypt, where they built the Sphinx and the Valley Temple at Giza and taught agriculture and precision tooling to the people—until the post-ice-age climatic chaos around 10,500–9500 BC sent them to higher ground, to what is now Kurdistan.

Collins claims that the legacy of the Elder Gods can be seen in places like Nevalı Çori in south-eastern Turkey, dated to at least 8,000 BC, where advanced agricultural, architectural and technological practices preceded the Sumerian civilisation by several

thousand years. Collins identifies the Lake Van region (the source of the Tigris and Euphrates rivers) as the biblical Garden of Eden, but concedes it is still not the home of the Elder Gods.

Collins goes on to say that when the Sumerians finally found their roots, they established Egypt's first dynastic line—the secrets of the Gods being under the protection of the Heliopolis priesthood who later influenced the Hebrew tribes.

The source of these Gods is still elusive, for they have left evidence at megalithic sites not only in Egypt and eastern Turkey, but in Central and South America, Europe and even Australia. Collins thus leaves us none the wiser as to their origins, but takes us on a fascinating journey nonetheless.

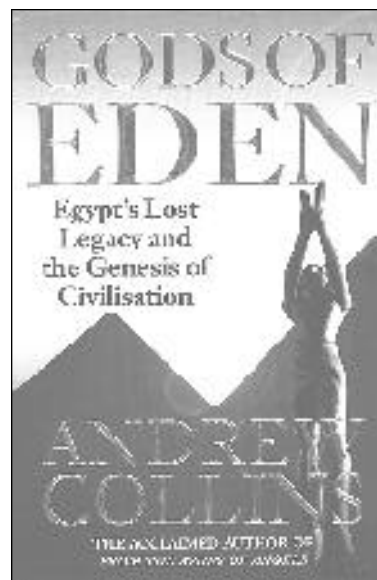



REVIEWS

BOOKS

VACCINATION ROULETTE: Experiences, Risks and Alternatives from Australian Vaccination Network

Publisher: AVN, Bangalow, NSW, 1998
ISBN: 1329-4873 (326pp s/c)
Price: AUD\$28.00 inc. p&h; AUD\$35.00
airmail NZ; AUD\$40.00 airmail else-
where; STG£14.50 inc. p&h in UK
Distributors: **Australia**—Australian
Vaccination Network, PO Box 177,
Bangalow, NSW 2479, ph +61 (0)2 6687
1699, fax +61 (0)2 6687 2032; **UK**—
NEXUS office.

Vaccination is a gamble against unknown odds, but in the interests of informed decision-making the Australian Vaccination Network (AVN) has produced this aptly titled compendium, *Vaccination Roulette*.

The AVN stresses that people need to be more aware of vaccine dangers. Adverse side-effects are considerably underreported or misdiagnosed by ill-informed doctors, while politicians use statistics and defy logic to justify the perceived broad social benefit at the expense of individuals who die or are severely disabled by vaccines.

So AVN has selected contributions from scientists, doctors and researchers on the risks and (few) benefits of a variety of vaccines, and has included some truly heart-rending stories from parents whose children have suffered at the hands of the medical/pharmaceutical 'mafia' or have experienced favourable results with vaccine alternatives.

The AVN editors themselves have written an incisive intro and conclusion of particular relevance in Australia: their stance is that

"it is morally, ethically and scientifically impossible to justify or to enforce compulsory vaccination". In any case, as they point out, the Australian government is stopping just short of compulsory childhood vaccination lest it follow US experience and have massive damage payouts on its hands.

Vaccination should be a matter of informed choice, so, with this in mind, AVN has provided support group contacts and resources both for Australia and overseas as well as substantial research references.

THE SECOND MESSIAH by Christopher Knight & Robert Lomas

Publisher: Century, UK, 1997
ISBN: 0-7126-7719-4 (267pp h/c);
0-0992-2732-0 (s/c)
Price: AUD\$39.95 (h/c), \$16.95 (s/c);
NZD\$18.95 (s/c); STG£8.00 (s/c) inc. p&h;
NLGf61,90 (h/c)

Distributors: **Aust/NZ/UK**—Random House; **UK/Eur**—NEXUS offices.

In their ongoing quest to find the missing history of Freemasonry, Christopher Knight and Robert Lomas (authors of *The Hiram Key*) further explore the rise and (official) fall of the Knights Templars in their follow-up book, *The Second Messiah*.

Their fact-finding mission takes in the fall of Jerusalem in AD 70 but then jumps a thousand years to 1118 with the Messianic bloodline heirs returning to Jerusalem to 'retrieve' the 'treasure' buried under the Temple and become its guardians. These Knights Templars rediscovered and practised the ancient traditions, including kingship and priesthood rituals, and accumulated immense wealth—but were outlawed by Philip IV of France and the Church in 1312.

The authors were surprised to learn the

ancient and mediaeval roots of many higher-degree rituals of the Ancient Scottish Rite of Freemasonry. One ritual relates to the mock Crucifixion torture of Grand Master Jacques de Molay (the second Messiah?) in 1307. They were astounded to learn that the photographic image on the so-called Shroud of Turin is quite probably that of Jacques de Molay. The ritual cloth absorbed his bodily secretions which became fixed over time by natural chemical reactions.

Such a revelation will not be popular with the Church or among the faithful—nor with certain Freemasons. Indeed, the authors despair at how certain rites perpetuated by the Knights Templars have been abandoned or corrupted by ignorance and Masonic vested interests in the last 300 years.

Surely now is the time for the 'guardians' to reveal the truth?

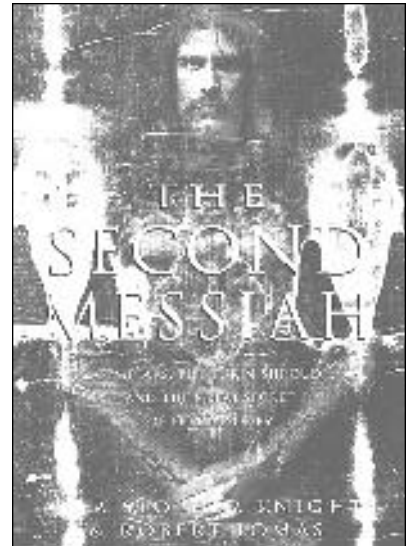

REVIEWS



BOOKS

CAN BACTERIA CAUSE CANCER?

by David J. Hess

Publisher: New York Uni. Press, 1997

ISBN: 0-8147-3561-4 (233pp h/c);

0-8147-3562-2 (s/c)

Price: AUD\$50.00; STG£24.00;

NLGf\$59.90; USD\$26.95

Distributors: **Aust**—Cameron Books, ph

(02) 4758 7676; **UK/Eur**—NEXUS offices;

USA—New York University Press, ph

1800 996 6987 (toll-free in US), website,

www.nyupress.nyu.edu.

Today, the consensus on the link between bacteria and cancer is that bacteria isolated from cancer tissues represent secondary infections that have nothing to do with tumour genesis. But there is a fascinating research tradition into a bacterial (or microbial) cause for cancer.

As anthropologist/science studies professor David J. Hess explains in *Can Bacteria Cause Cancer?*, the consensus arose due to several factors. It was a combination of suppression, the power of financial and professional interests plus the cultural and gender-logical factors of an increasingly industrialised climate that caused the demise of promising research and therapies, including cancer vaccines, from Coley, Glover, Rife and Livingstone, and the rise of invasive surgery and toxic treatments.

Cancer research became institutionalised, and new specialisations arose that had little knowledge of the theory or implications of pleomorphism: that micro-organisms have multiple evolutionary stages. The theory as

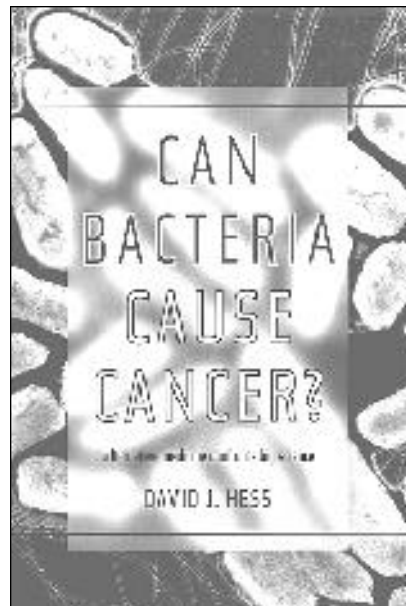

espoused by Antoine Béchamp was considered extreme and was discounted by the medical 'establishment' of the day. In view of DNA research since the 1950s, Hess, too, discounts the extreme pleomorphic view.

Though he rejects the single microbe theory, Hess argues for the overhaul of cancer research, therapies and policies to allow further investigation of promising alternative theories and treatments. Research into bacterial, fungal, viral, parasitic and amoebic causation does continue today, albeit underground and with little recognition.

THE CASE FOR THE FACE: Evidence for Alien Artifacts on Mars

edited by Stanley V. McDaniel and Monica Rix Paxson

Publisher: Adventures Unlimited, 1998

ISBN: 0-932813-59-3 (311pp s/c)

Price: AUD\$30.00; NZD\$36.50;

STG£15.50; NLGf\$39.90; USD\$17.95 +

postage & handling

Distributors: **Aust/NZ/UK/Eur**—NEXUS

offices; **USA**—Adventures Unlimited, PO

Box 74, Kempton, IL 60946, ph (815) 253

6390, fax (815) 253 6300.

The so-called "Face" in the Cydonia region of Mars, first photographed by the Viking mission in 1976 and again by the Mars Global Surveyor in early April this year, is nothing more than a natural geological formation, a mesa, according to NASA. The media have been dismissive, seizing a chance to denigrate the "conspiracy theorists" who claim there is evidence for the formation being an artificial structure or at least a natural form that has been sculpted by other than just natural erosion processes.

Many of these alleged "conspiracy theorists" happen to be respected space scientists, physicists, photographic specialists, engineers, geologists and anthropologists—some of whom have even worked for NASA. A collection of their research into the Martian mysteries has been compiled in *The Case For The Face*, released just prior to the first Global Surveyor image.

A browse through this book does strike it home how a considerable body of evidence for the Face can be rejected outright with just one photo taken from one view without any variation of light angle or distance—and rejected by scientists and reporters who have barely investigated the Face, let alone the landscape anomalies of the nearby "City", which are in square-root-of-two relationship to each other. The release of the City images in late April has not quelled the controversy (see Twilight Zone this issue).

No one wants to 'lose face' over these anomalies, but closer study is warranted if all the questions are to be answered.



REVIEWS

BOOKS

THE KEYS TO THE TEMPLE

by David Furlong

Publisher: Piatkus Books, UK, 1997

ISBN: 0-7499-1745-8 (312pp h/c)

Price: AUD\$34.95; NZD\$49.95;

STG£16.99; NLGf61,90; USD\$16.95;

CAN\$27.95

Distributors: **Aust**—Hodder Headline, ph (02) 9841 2800; **NZ**—David Bateman Ltd, ph (09) 415 7664; **UK**—Piatkus Books, ph 0171 631 0710; **Europe**—NEXUS; **USA**—London Bridge, ph 1800 805 1083; **Can**—General Publishing, 1800 387 0141.

In 1975, David Furlong (a surveyor/town planner and a practising healer) made an exciting discovery while studying the patterns, alignments, sacred sites and ley energies of Marlborough Downs, Wiltshire, UK.

He identified a twin-circle pattern (a *vesica pisces* design), each with a radius of 5.96 miles (9,570 metres), upon which lies an array of barrows, tumuli, henges such as Avebury, and churches (some built on pre-existing sites) in geometric relationship with each other and with other major ley lines.

The next year he discovered, hidden within its design, the geometric blueprint of the Great Pyramid of Khufu at Giza in Egypt!

The Keys to the Temple is the culmination of 25 years of research into this relationship. Furlong draws on the groundbreaking 'ley-hunting' research of Alfred Watkins in the 1920s and John Michell who identified the St Michael's ley in his 1969 book, *View Over Atlantis*. He also speculates on what the Knights Templars knew about the site's parallels with the Pyramid's secrets.

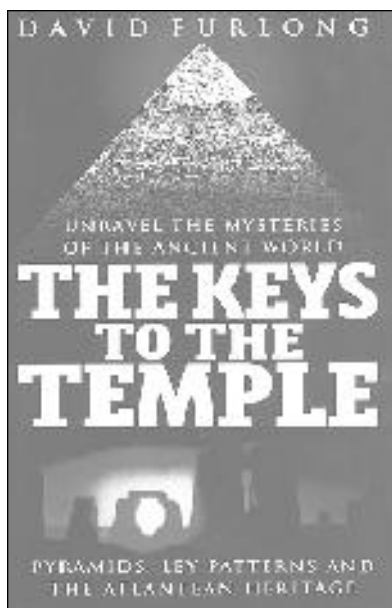

Furlong argues that the emergence of the stone circle epoch in Neolithic Britain coincided with the rise of dynastic Egypt around 3,100 BC. The progenitors of these cultures were survivors of a catastrophe and passed on their advanced knowledge of astronomy, geometry, surveying, engineering and masonry to the people in these distant lands. His claim that this catastrophe was the final fall of Atlantis conflicts with another school of thought that marks it at circa 10,500 BC.

Applying his surveying and computing skills, Furlong presents a compelling explanation for how the ancients designed their complex landscape alignments.

BRINGING THE WAR HOME

by William Thomas

Publisher: Earthpulse Press, USA, 1998

ISBN: 1-890693-24-3 (444pp h/c)

Price: AUD\$40.00; STG£18.50;

USD\$19.95 + p&h

Distributors: **Aust**—Cameron Books, ph (02) 4758 7676; **UK**—NEXUS office;

USA—Adventures Unlimited, ph (815) 253 6390, fax (815) 253 6300.

The devastating effects of the Persian Gulf War will be felt for generations to come. More than 100,000 US and UK service personnel, their spouses and children stricken with a variety of illnesses broadly defined as "Gulf War syndrome", can attest to this—as can millions of Iraqi civilians.

In *Bringing the War Home*, Canadian journalist/activist William Thomas writes a hard-hitting exposé of the military, sci-tech, political and ecological madness before, during and since the Gulf War. To the detriment of his own health, Thomas worked in the region with GEERT, the Gulf Environmental Emergency Response Team he helped form right after the Gulf oil spill that came ashore on the Saudi Arabian coast.

Thomas documents the facts the Pentagon actively denies: chemical and biological warfare by Iraq (denied because between 1985–1989 American taxpayers subsidised the export of large quantities of CBW raw materials to Iraq); the US use of depleted uranium shells that often backfired on their own troops and are implicated in the growing incidence of cancer and deformities in Iraqi children; and the vast array of illnesses attributed not only to CBW attack and oil/oilfire pollution but an untested cocktail of vaccines, pesticides and other contaminants.

Thomas is not afraid to expose the military-industrial war machine that refuses to take responsibility for the horrors it has unleashed. He writes of the suffering soldiers and their families, and the scientists who, against the odds, attempt to understand their symptoms and alleviate their pain.

REVIEWS



BOOKS

MILK: The Deadly Poison by Robert Cohen

Publisher: Argus Publishing, USA, 1998
ISBN: 0-9659196-0-9 (330pp h/c)
Price: STG£22.00; NFG\$54.90;
USD\$24.95; CAN\$34.00

Distributors: **UK/Europe**—NEXUS offices;
USA—Argus Publishing, Inc. 301 Sylvan
Avenue, Englewood Cliffs, NJ 07632, ph
(201) 871 5871, toll-free 1888 668 6455,
fax (201) 871 9304.

Contrary to what the dairy industry would have us believe, milk and dairy products are by no means a recipe for good health. Cow's milk contains bovine growth hormones, bacteria and antibiotics, cholesterol and fat, pesticides and viruses, to name but a few substances, and is implicated in causing breast cancer, osteoporosis, heart diseases and chronic childhood illness. It cannot be digested by any mammals beyond infancy—and humans are no exception.

But what happens when dairy cows are injected with a genetically engineered bovine growth hormone? Apart from the cows suffering adverse health effects like mastitis (they're not meant to produce milk in the quantities demanded by modern industry), their milk creates significantly increased levels of the insulin-like growth factor 1 (IGF-1) which is identical in cows and humans. The hormone is not killed by pasteurisation or human gastric acids, and its bioactivity rises nearly 30 times in the presence of oestrogens. When nations with the highest rates of breast cancer have the highest per-capita intake of milk and dairy

products, is it wise for engineered growth hormones to be foisted on consumers?

All this and much more is excruciatingly documented by Robert Cohen in *Milk: The Deadly Poison*. Following the US FDA's approval of rBGH in 1993, he embarked on a fact-finding crusade that revealed collusion between Monsanto (the company that developed rBGH), various authorities (the FDA, NIH, USDA, AMA) and Congress. Between them they sanctioned a substance that has never been tested in human trials, and that the European Community has even deemed unsafe. You have been warned!

THE MYSTERY OF EASTER ISLAND by Katherine Routledge

Publisher: Adventures Unlimited, USA,
1998 (first published 1919)
ISBN: 0-932813-48-8 (404pp s/c)
Price: AUD\$28.00; NZD\$34.90; STG£15;
NLG\$37.90; USD\$16.95 + p&h
Distributors: **Aust/NZ/UK/Eur**—NEXUS
offices; **USA**—Adventures Unlimited, PO
Box 74, Kempton, IL 60946, ph (815) 253
6390, fax (815) 253 6300.

In 1913 a scientific expedition set sail from Southampton, England, aboard the yacht *Mana* on what would be a 2½-year journey. *The Mystery of Easter Island* (first published in 1919 and now reprinted), documents their outward voyage down South America and around Patagonia, the eighteen months they spent on Easter Island, and their homeward journey via Pitcairn Island, Tahiti, Hawaii and San Francisco, through the Panama Canal to Jamaica and Bermuda and then back home to England.

The author, Kathleen Routledge, accompanied her husband not only to document the voyage in words and sketches but, particularly on Easter Island, to study the inhabitants' cultural and historical background while he investigated their artefacts.

Her book remains a valuable sourcebook for what it tells of the Easter islanders' lives and the legends about their origins and wars, their strange *rongo-rongo* script (only recently deciphered), their "bird cult" rites (still being practised in 1914), and, of course, their enigmatic stone statues—most of which had been toppled or destroyed in the preceding 200 years of European presence on the island. Routledge surmises that the islanders' ancestors migrated there in 'waves' no longer than 1,000 years ago.

The expedition members explored the island's secret caves, roads, pyramid platforms and rock carvings as well as the statues, some still only half-cut in their quarries. Their intrepid wanderings and meetings were amply photographed, illustrated and mapped for this now-classic text.

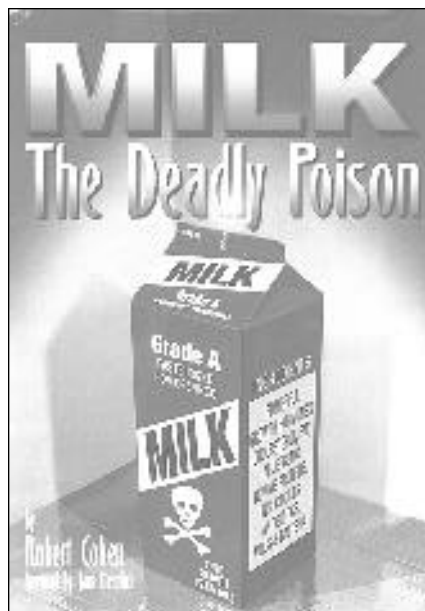



REVIEWS

THE SIRIUS MYSTERY

by Robert Temple

Publisher: Century, UK, 1998

ISBN: 0-7126-7874-3 (440pp h/c)

Price: AUD\$35.00; NZD\$39.95;

STG£17.50 inc. p&h; NLGf61.90

Distributors: **Aust/NZ/UK**—Random

House; **UK/Eur**—NEXUS offices.

The 1976 release of *The Sirius Mystery* created huge public interest and a scientific furore. Since then, author/scholar Robert Temple has endured ill-argued criticism from academia, and ill-placed attention from several 'intelligence' agencies, to continue his research and produce a revised, expanded edition of his milestone book.

The thesis of *The Sirius Mystery* focuses on the Dogon tribe of Mali, whose ancient traditions and legends incorporate knowledge about the Sirius star system. (The invisible Sirius B was only discovered last century and not photographed until 1970, while Sirius C was only confirmed in 1995.)

Temple argues that the ancestors of the Dogon migrated to the region, taking with them knowledge they obtained from a common source that influenced the Sumerians and Egyptians about 5,000 years ago. That source, he suggests, was visitors from Sirius, who passed on their astronomical, mathematical and technological knowledge.

Anubis the dog (protector of the secrets) and the "Dog Star" Sirius were important to the Egyptians, and Temple points to evidence that the Sphinx was not a statue of a lion but of Anubis. He explains the water erosion on the Sphinx as being the result of its body being surrounded in ancient times by a water-filled moat that periodically silted up and had to be drained. This also accounts for the head of the Sphinx showing

less erosion than the body. So, he argues, the erosion was not caused by severe climatic change, and thus the Sphinx is younger than geologists like Robert Schoch suggest—maybe only 5,000 or so years old.

Temple also identifies a fascinating discrepancy in the dimensions of the two largest Giza pyramids that equates with the 1.053 mass differential between Sirius B and our Sun—the so-called "sacred fraction". This, he believes, can be no accident, and smacks of intervention from the stars.

KOMBUCHA TEA FOR YOUR HEALTH AND HEALING

by Alick & Mari Bartholomew

Publisher: Gateway Books, UK, 1998

ISBN: 1-85860-049-9 (190pp s/c)

Price: AUD\$26.95; NZD\$39.95;

STG£10.00; USD\$14.95; CAN\$21.95 +

\$3.95 p&h

Distributors: **Aust**—Banyan Tree Book Distributors, ph (08) 8363 4244; **NZ**—Peaceful Living Publications, ph (07) 571 8105; **UK**—NEXUS office; **USA**—Access Publishers Network, ph (616) 276 5196, 1800 345 0096; **Canada**—Temeron Books, ph (403) 283 0900.

The authors of this comprehensive guide to kombucha (the healing fungus with an illustrious ancient Eastern history) have included up-to-date research in order to make both orthodox and complementary health practitioners more aware of its amazing properties as a metabolic balancer, a probiotic, an adaptogen and a detoxifier.

The book, *Kombucha Tea for your Health and Healing*, was written by Alick and Mari Bartholomew (he the publisher of Gateway Books, and she a shiatsu therapist), who started The Kombucha Tea Network in the UK in 1993. (Alick, by the way, was instrumental in producing a revised edition of Harald Tietze's *Kombucha: The Miracle Fungus*, which he first came across in a NEXUS review! Indeed, Harald's book has been the Network's bible ever since.)

Just about all you need to know about how the kombucha fungus works, how to prepare a culture and how to brew the tea successfully is covered in the Bartholomews' book. There's a summary of medical research, an extensive Q&A section, an A-Z of diseases and imbalances that can be treated with the fungus, plus information on contraindications, cancer prevention, first aid, holistic self-healing, recipes, cosmetics and caring for animals and plants.

The Bartholomews also include detailed case histories from kombucha users who attest to its efficacy and empowering benefits. If you've not yet explored this phenomenal fungus, this is a great place to start.

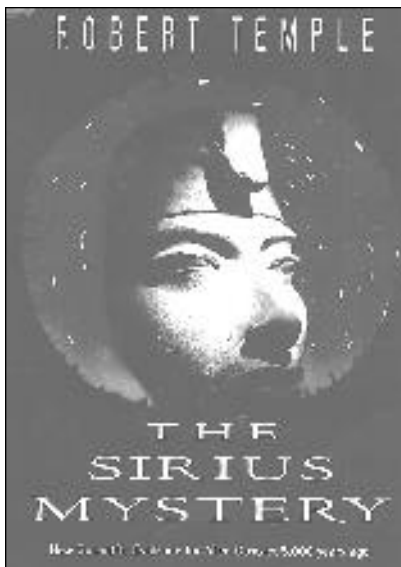

REVIEWS



VIDEOS

Reviewed by Duncan Roads

LETHAL MEDICINE

Producer: The Nature of Wellness, USA, 1997 (PAL & NTSC, 55mins)
Price: AUD\$38 in Aust; AUD\$41.50 to NZ; USD\$40 to UK/Eur; USD\$27 in USA; USD\$35 to Canada/Sth America
Distributors: **Aust/NZ**— Campaign Against Fraudulent Medical Research, PO Box 234, Lawson NSW 2783, Australia, phone/fax +61 (0)2 4758 6822, e-mail, cafmr@pnc.com.au; **USA/Can/UK/Eur**— The Nature of Wellness, PO Box 10400, Glendale, CA 91209-3400, ph (818) 790 6384, fax (818) 790 9660, e-mail, supress@earthlink.net, website, www.animalresearch.org.

This is without a doubt the very best documentary I have ever seen that details the subject of animal experimentation. If you're squeamish, don't worry; this is not a video that relies on emotive animal-suffering imagery to capture your attention and support. This is a video that deals with the scientific facts!

It is a scientific fact that an animal's reaction to drug- or substance-testing bears absolutely no relevance to that substance's effects on humans. The documented evidence presented here by experts will astound and amaze all viewers, even the 'converted'.

The viewer gradually realises that because the species are so different, it is a complete and cruel fallacy to assume that drugs and substances are therefore safe for human exposure or consumption. Many, if not most, of the horrific side-effects of modern medicine occur largely because substances are not tested on humans but on animals—hence the title, "Lethal Medicine".

Everyone should watch this video!



VACCINATION: The Hidden Truth

Producer: Taycare Pty Ltd, Australia, 1997 (PAL & NTSC, 90mins)

Price: AUD\$40.00 inc. p&h; NZD, STG, NLG, USD prices on application
Distributor: **Aust/NZ/UK/Eur**— NEXUS offices; **Aust**—Taycare Pty Ltd, Suite 20, 10-12 Ray St, Turrumurra NSW 2074, ph (02) 9144 6625, fax (02) 9440 3001, e-mail, taycare@byronit.com; **USA**—New Atlantean Press, ph (505) 983 1856.

What can I say? Again, this is without a doubt the very best documentary in terms of content on the subject of vaccines and immunisation that I have ever seen! It is jammed full of scientific facts, all drawn from peer-reviewed medical literature and delivered by doctors and researchers who, after investigating the subject, are speaking out about the dangers.

If you or your friends don't have time to read books on the subject of vaccination, then get this video. It is tremendously informative on all aspects of the debate, including how to tackle fixing the damage caused by vaccines.

This is a video that every doctor should watch and respond to. It is a sad day when doctors rely more on drug company propaganda for information than their own peer-reviewed literature!

HIGH STRANGE NEW MEXICO

Producer: Taos Communications Empire, USA, 1997 (107mins)

Price: USD\$24.95 + \$4.00 p&h (+ \$1.45 sales tax in NM)

Distributor: **USA**—Taos Communications Empire, Inc., 4221 Brockmont NE, Albuquerque, NM 87108, ph (505) 260 0965, e-mail Honalu@aol.com.

Don't be put off by the title! This great movie covers much more than just 'high strangeness' in New Mexico.

Sure, it covers the Roswell incident and Socorro, the waves of UFOs overflying large towns in broad daylight during the 1950s and many other unexplained phenomena, but, utilising interviews, etc., it also explores what's going on in people's heads about it all—which extends the boundaries well beyond New Mexico!

I like the fact that the producers gave time to people who were mildly sceptical, as well as time to people directly involved with each case. The video gives what I consider to be an accurate perspective on what is going on in many people's minds, and thus captures the current pulse of ufology extremely well.

This is not a video that tries to convince you of anything. It is well edited, well documented and, overall, leaves you thinking. As you can tell, I like it!



REVIEWS

AUDIO

Reviewed by Richard Giles

THE MUSIC OF ISLAM (compilation)

Producers: David Parsons for Celestial Harmonies, Arizona, USA, 1997 (79mins)
Distributors: **Australia**—Festival, ph (02) 9660 4022; **USA**—Celestial Harmonies, ph (520) 326 4400, fax (520) 326 3333; US orders, Hear's Music, 1800 501 3472.

One of the misfortunes of the long history of stereotyping and conflict between Islam and the West is that it has fostered ignorance of one another's great music and culture, but David and Kay Parsons, working in cooperation with Celestial Harmonies of the US, have laboured for 10 years to produce this amazing collection. There are 15 albums in the set, covering the entire Islamic belt from Morocco to Indonesia, where one-fifth of the world's people live. This compilation CD has representative tracks from 10 countries as a sampler. A must-have collection, lovingly put together.

STORMBIRD

by Matthew Doyle and Tony Lewis

Producers: Tony Lewis for One World Music, Australia, 1998 (56mins)
Distributors: **Australia**—One World Music, ph (07) 3367 0788; **UK**—New World Music, ph 0198 678 1682.

Australian Aboriginal didgeridoo has been resonating around the planet and is the new 'in' ethnic instrument, like the djembe. Matthew Doyle has recorded three previous albums of didgeridoo music and has been involved with didge and dance for over 15 years as well as with various music and dance projects around the world. For *Stormbird*, he's joined with percussionist/composer Tony Lewis and put together an album of raw, traditional-style didge, backed by Tony's international mix of percussion, whistle, flute, congas and cymbals.



EMER KENNY (self-titled)

Producer: Jeffrey Lesser for Triloka Records, USA, 1998 (51mins)

Distributors: **Australia**—Mercury/PolyGram, ph (02) 9207 0500; **USA**—Triloka/Mercury, ph (310) 996 7200.

A first release from a new Irish singer who blends traditional Celtic with a more contemporary style. Her voice is often very ethereal and floating in style and at times haunting in its impact. Producer Jeffrey Lesser has worked with the likes of The Chieftains and Sinead O'Connor. On Kenny's album he combines pipes, violins, harp (Emer is also a classical harpist), flute and guitars with contemporary keyboards to produce remarkably eclectic arrangements of both the visionary and the ancient in Irish music. A new talent from Eire is abroad!

CAFE PARADISO

by Steve Erquiaga

Producers: Dawn Atkinson and Steve Erquiaga for Imaginary Road Records, USA, 1997 (60mins)

Distributors: **Australia/NZUK** /**USA**—PolyGram Records.

To hear a skilled guitarist play is such a treat. There are so many albums of acoustic guitar being released today and it's great to find one of such exemplary quality as *Café Paradiso*. Steve Erquiaga specialises in contemporary arrangements of the classics and he's done a superb job with these. He includes Bach's "Arioso" and "Prelude in C Minor", Rachmaninov's "Sérénade", and his arrangements of themes from *Cinema Paradiso*. His work has appeared in a number of film soundtracks, including *The Firm* and *Forrest Gump*. Smooth and mellow music from a master of the guitar.

CHAKRADANCER

by Brainscapes

Producer: Alain Eskinasi for Cyber Octave, Malibu, USA, 1997 (59mins)

Distributors: **Australia**—MRA Entertainment, ph (07) 3849 6020; **USA**—Higher Octave Music, fax (310) 589 1525.

Brainscapes is a project of music metaphysician Alain Eskinasi. Experimenting in new ground in musical composition, this album is one of Eskinasi's series using therapeutic music techniques based on the Chinese elements, chakra toning, sound imaging, meditation and trance dance. The techniques are designed to stimulate (not relax) the seven chakras and open up the body's energy centres for creative work and enjoyment. Using seven crystal bowls arranged in the traditional chakra set, he mixes his sound landscapes with ethnic percussion. The result is remarkable.

The Hidden History of Jesus and the Holy Grail

Continued from page 18

Throughout the ages, parliaments and governments have had as much trouble as the Church in confronting the Messianic social code, and the position is no different today. Presidents and prime ministers are 'elected' by the people. They are supposed to represent the people. But do they? In actual fact, they don't. They are always affiliated to a political party, and they achieve their positions by way of majority party vote. But not everybody takes the trouble to vote, and sometimes there are more than two parties to vote for. Consequently, at any given time, more than half the people of a nation may not be represented by the political party in power. In this regard, even though a 'majority vote' has been applied, the democratic principle fails. What emerges is not "government *by* the people, *for* the people", but "government *of* the people".

Jesus confronted a very similar situation in the first century. At that time, Jerusalem and Judaea were under Roman occupation, with King Herod and the Governor, Pontius Pilate, both appointed by Rome. But who represented the people? The people were

not Romans; they were Holy Land Jews—Pharisees, Sadducees, Essenes and the like. Apart from that, there were large numbers of Samaritans and Gentiles (non-Jews, the Arab races). Who represented them? The answer is "no one"—until Jesus made it his mission to do so.

This was the beginning of the Grail code of non-affiliated princely service—a code perpetuated by the Messianic dynasts in their continuing role as "common fathers" to the people. The Grail code is based on the principles of liberty, fraternity and equality, and it was particularly apparent in the American and French revolutions, both of which discarded the lordship of despotic aristocracy. But what has replaced it? It has been replaced by party politics and largely non-representative government.

From the Middle Ages there were a number of chivalric and military orders specifically attached to the Messianic Blood Royal in Britain and Europe. They included the Order of the Realm of Sion and the Order of the Sacred Sepulchre. But the most prestigious of all was the Sovereign Order of the *Sangréal*—the Knights of the Holy Grail. This was a dynastic order of Scotland's Royal House of Stewart, the

royal house which in the 14th century introduced the unicorn of the Cathars as the sovereign emblem of Scotland. Shortly afterwards, they introduced the prestigious Order of the Unicorn, which carried the Grail motto "All as One".

Like King Arthur, the Stewart Kings also had a dual Desposynic heritage from both Jesus and his brother James. In fact, from the 1370s they were the senior house of the Messianic line, and they were Europe's longest-reigning dynasty, holding their crown for 317 years until finally deposed by the Anglican Church in 1688. They were deposed because, in compliance with the Grail code, they claimed affinity to God and the nation before Parliament, the Church and the aristocracy.

Today, the senior legitimate descendant in this line is HRH Prince Michael Stewart, Count of Albany (whose own book, *The Forgotten Monarchy of Scotland*, is scheduled for publication by Element Books in May 1998).

And now to a question that I have frequently been asked in the months since *Bloodline of the Holy Grail* was published. The question is: why is all this

The Hidden History of Jesus and the Holy Grail

Continued from page 83

information coming to light at this particular time?

The fact is that the information has never been suppressed by those whom it concerns. It has been suppressed by outside power-seekers who have sought to serve their own ends, rather than serve the communities they are supposed to represent.

Today, however, we are in a new age of 'questing', as many people grow more disillusioned with the establishment dogmas that prevail. We live in an age of satellite communications, sound-barrier travel, computers and the Internet—so the world is effectively much smaller than before. In such an environment, news travels very quickly, and the truth is far more difficult to restrain.

Also, the very fabric of the 'male-dominated' Church and governmental structures is being questioned, and it is generally perceived that the old doctrines of spiritual control and territorial management are not working. More and more people are searching for the original, uncluttered roots of their faith, and for their purpose in society. They are seeking more effective forms

of administration to combat the all-too-apparent slide into social and moral decline. They are, in fact, questing for the Holy Grail.

This quest for new enlightenment is considerably heightened by the coming new millennium, and there is a widespread feeling that this should also present a new Renaissance, an era of rebirth wherein the precepts of the Grail code are acknowledged and practised—the precepts of liberty, fraternity and equality.

Grail lore spells out loud and clear that the wound of the Fisher King must be healed if the wasteland is to return to fertility. And so, given that I had been afforded privileged access over past years to the archives of the Knights Templars, the Celtic Church and the Messianic sovereign houses of Europe, the time arrived for me to play my own small part in trying to heal the age-old wound of the Fisher King. The result was my book, *Bloodline of the Holy Grail*.

About the Speaker:

Sir Laurence Gardner, Kt St Gm, KCD, is an internationally known sovereign and chivalric genealogist. He holds the position of Grand Prior of the Celtic Church's Sacred Kindred of Saint

Columba, and is distinguished as the Chevalier Labhrán de Saint Germain. Sir Laurence is also Presidential Attaché to the European Council of Princes, a constitutional advisory body established in 1946. He is formally attached to the Noble Household Guard of the Royal House of Stewart, founded at St Germain-en-Laye in 1692, and is the Jacobite Historiographer Royal.

Editor's Notes:

- Sir Laurence Gardner will be a guest speaker at the 1998 NEXUS Conference, 25-26 July, in Sydney, Australia.
- Correspondence should be addressed to Sir Laurence Gardner, Kt St Gm, KCD, c/- Element Books, Shaftesbury, Dorset, SP7 8DP, United Kingdom.
- Laurence Gardner's book, *Bloodline of the Holy Grail: The Hidden Lineage of Jesus Revealed*, contains the detailed story upon which this lecture was based. It was published by Element Books in 1996 (ISBN 1-85230-870-2 h/c), and is now available in paperback (ISBN 1-86204-152-0), distributed by Penguin Books and widely available through bookshops. It was reviewed in NEXUS 4/01. The second book in his Grail bloodline trilogy is *Genesis of the Grail Kings*, which is scheduled for publication in (northern) Spring 1999.
- Copies of Laurence Gardner's video presentation can be obtained from NEXUS Office in the UK; and in the USA, from Ramtha's School of Enlightenment, PO Box 1210, Yelm, WA 98597, telephone +1 (360) 458 5201, website, www.ramtha.com. Orders from Australia and NZ should be sent to the USA; cost, AUD\$46.00 inc. p&h, for both tapes (specify PAL/VHS).

Continued from page 32

and share relevant information.⁹²

Stigson wrote to OECD official Don Johnston, expressing his concern about the inclusion of binding language on environmental standards in the MAI, and, in the same letter, he generally promotes the WBCSD's gospel of business self-regulation.⁹³

Quoting Agenda 21,⁹⁴ Stigson argues that "trade liberalisation is a positive force for supporting the most environmentally and economically efficient use of goods and resources, and hence for contributing to sustainable development".

He then concludes that "investment liberalisation is a close relative of trade liberalisation, and can be expected to produce a similar positive impact". He expects that the greatest benefits will arise from the inclusion of Third World countries in the MAI.

Stigson acknowledges possible conflicts between new environmental regulation and the MAI, and suggests these could be solved by "making explicit the types of assurances that business and many negotiators say is already in the agreement, while

maintaining the very important goals of the MAI". He suggests that the reference to NAFTA Section 114.1 in the MAI draft already "ensures all stakeholders a balanced implementation of the agreement in dispute resolution processes". This, however, is hardly reassuring. This very clause did not prevent the US Ethyl Corporation from challenging a Canadian environmental law as an expropriation in a NAFTA court last year.

In his letter, Stigson expresses strong reservations about a provision under which countries would obligate themselves not to reduce their environmental standards in order to attract or maintain investments, be it non-binding or mandatory. He does not altogether reject mandatory provisions, provided these can really be enforced and will bring clear benefits. Stigson also recognises that the MAI could encourage companies to shift investment to pollution havens.

Rather than including environmental standards for investments in the MAI, he suggests the WBCSD 'solution' of "sound environmental management systems as an alternative to command and control environmental standard setting".

Endnotes

46. Chakravarthi Raghavan, *Third World Network Features*, 1404/96, p. 1.
47. Chakravarthi Raghavan, *Third World Network Features*, 1527/96.
48. The eight countries were Egypt, Ghana, Haiti, India, Indonesia, Malaysia, Tanzania and Uganda. The position of the eight countries was later echoed by the 11 trade ministers of the Southern African Development Community (SADC). Source: Martin Khor, *Third World Network Features*, 546/96, p. 5.
49. *Idem*, p. 4.
50. *Idem*.
51. "The Outcome of Singapore: Statement by Sir Leon Brittan, Vice-President of the EU Commission", IP/96/1172, 13 December 1996.
52. Martin Khor, *Third World Network Features*, 1547/96, p. 4.
53. Interview with Mr Koulen, WTO Division for Intellectual Property Rights and Investment, 30 January 1998.
54. Report (1997) to the General Council.
55. "Investment Liberalisation: A New Issue for the WTO", Address by the Right Honourable Sir Leon Brittan, Vice-President of the European Commission, Cologne, 11 June 1996.
56. "World business urges global investment pact", ICC statement from 11 November 1996. The World Investment Forum took place on 10 October 1996 in Geneva, Switzerland.
57. *The Nation*, 24 December 1997.
58. The Chambers of Commerce are organised in the International Bureau of Chambers of Commerce (IBCC).
59. Interview on 29 January 1998 with Vincent J. O'Brien, Deputy Director of Communications, ICC.
60. ICC, "The World Business Organization in

1997", p. 4.

61. ICC Commission on International Trade and Investment Policy, Document no. 103/179 Rev., 30 April 1996.

62. Ibid, p. 3.

63. The ERT is a think-tank, research and lobby group representing some 47 of the largest European transnational corporations in Europe. For more information see CEO report, "Europe, Inc."

64. ERT, "European Industry and the Developing World – For a Global Framework of Mutual Interest and Trust", June 1997, p. 9.

65. ERT, "European Industry: A Partner for the Developing World. Foreign Direct Investment as a Tool for Economic Development and Cooperation: Suggestions for Future Improvement", 1993, p. 35.

66. ERT, "Investment in the Developing World: New Openings and Challenges for European Industry", December 1996, p. 13.

67. ERT, "Survey on Improvements in Conditions for Investment in the Developing World", 1993.

68. ERT, "Investment in the Developing World: New Openings and Challenges for European Industry", December 1996, p. 13.

69. Peer review is a traditional system at the OECD in which countries are encouraged to reach common positions in a committee rather than through a dispute settlement procedure. Source of this section: ERT, "European Industry and the Developing World – For a Global Framework of Mutual Interest and Trust", June 1997, p. 9.

70. Idem; foreword by Helmut Maucher.

71. Idem, p. 5.

72. UNCTAD press release, 8 December 1997.

73. Phone conversation with UNICE, January 1998.

74. Joint statements from UNICE and Keidanren, 23 November 1995 and 13 December 1996.

75. Source: USCIB website,

<http://www.imex.com/uscib/>

76. Honeywell and General Electric were the first two companies investigated under NAFTA's side agreement for labour violations in their Mexican *maquilladoras*. Source: "USCIB's Corporate Crime Blotter, or Levelling the Playing Field for Felons", Michelle Sforza, Preamble Collaborative, draft, January 1998.

77. USCIB website.

78. USCIB press release, 24 May 1995.

79. Idem.

80. Idem.

81. USCIB's President Abraham Katz, letter to US Trade Representative Charlene Barshefsky.

82. "USCIB Concerns with Environmental Provisions for the MAI", USCIB President Abraham Katz's letter to US Deputy Trade Representative Jeffrey Lang, 11 July 1997.

83. The *Washington Times* is well known for the sympathetic representation of business interests in its pages. Fred Singer, leader of the Science and Environment Project, an industry lobby which organised an aggressive misinformation campaign against climate change prevention, is on the newspaper's council.

84. Timothy E. Deal, Senior Vice President, USCIB, "Why We Need the Multilateral Agreement on Investment", *Washington Times*, 25 December 1997.

85. Idem.

86. The FTA was the basis for the NAFTA treaty.

87. Stuart Carre, BCNI, in front of the Subcommittee on International Trade, Trade Disputes and Investment of the Standing Committee on Foreign Affairs and International Trade, 25

November 1997.

88. Idem. "This has cast a pall of uncertainty over the ability of US negotiators to deliver on any negotiated trade and investment agreements, and that includes the MAI."

89. Statement by Keidanren and UNICE at the WTO Ministerial Conference, Singapore, 13 December 1996.

90. Keidanren's "Views on MAI Negotiations", 17 June 1997.

91. The WBCSD has many renowned corporate polluters as members, including British Petroleum, Cargill, Fiat, General Motors, ICI, Lafarge, Monsanto, Nestlé, Philips, Procter & Gamble, Rio Tinto Zinc, Son, Statoil, Texaco, Toyota, Unilever, Volvo, Waste Management International, Western Mining Corporation and Weyerhaeuser.

92. E-mail from Marcel Engel, WBCSD, 29 January 1998.

93. Letter dated 9 January 1998.

94. Agenda 21 is the action plan which came out of the 1992 Rio Earth Summit.

About the Author:

This briefing was prepared by Belen Balanya, Ann Doherty, Olivier Hoedeman, Adam Ma'anit and Erik Wesselius for Corporate Europe Observatory (CEO), an Amsterdam-based non-profit organisation set up to monitor and report on the political activities of European corporations and their lobby groups. CEO encourages readers to spread this briefing or use the information contained in it, but would appreciate receiving a copy of any published article citing it. Interested parties who would like to be on CEO's e-mail distribution list should e-mail their details direct to Corporate Europe Observatory.

Continued from page 40

I've always resented my work being associated under the catch-all phrase "alternative medicine". My treatment involves an extremely focused hybrid of what is considered "conventional medicine". However, in my pursuit of any form of therapy that could augment or even supersede my own findings, I've always been interested in alternatives as opposed to conventional, toxic and often barbaric treatments.

Although there is hope of finding other practitioners who have medical information to offer, I have yet to find any breakthroughs that would complement my own.

I've been appalled to find alternative health organisations that sell juice drinks, vitamin C shots and laetrile powders to desperate patients—products costing hundreds and often thousands of dollars yet only costing a few cents to make.

It was in this spirit that I made this offer: US\$100,000 to any "alternative" therapy that can prove 10 cases of full cancer remission.

Additionally, I made this offer to the sceptical world of conventional medicine:

US\$100,000 to any reputable medical organisation that will test and publish the results of my AIDS and cancer vaccines.

No one has yet come forward to make a claim on these offers.

With the realisation that Induced Remission Therapy can offer favourable results now, and with the assistance of additional resources, medical industry professionals who are truly dedicated to curing disease, and have the ability to catalogue, store and culture autogenous vaccines on a large scale, could and would alter medical treatment as recognised today. Historically, institutions are resistant to change. Change comes slowly. So for any promising therapy to be accepted into the mainstream of medical practice, this would require a paradigm shift in medical science as we know it today.

IRT deals with maladies at the genetic level. Indeed, it is the only therapy now in application that concentrates on disease at this level. The matrix of many diseases is at the genetic level, so many types of illness can be treated with IRT.

Genetic correction is the only hope for achieving a cure in such disease conditions

as AIDS and cancer, and starkly contrasts the available toxic and inferior modalities that attack disease mechanisms and symptoms while leaving a damaged blueprint.

The best demonstration of this remarkable ability can be seen in the cases where HIV virus is genetically removed from the cell nucleus. Not only is the body purged of the disease, but it is able to repair damage suffered during the course of the illness. This opens up a new field of cellular regeneration never before possible.

The capacity to reverse age- and disease-related DNA damage opens a new world of therapeutic opportunity and almost limitless applications.

Editor's Notes:

- For further details, or to obtain videos on Dr Chachoua's Induced Remission Therapy, phone (213) 655 0271 in the USA; or visit website, www.peg.apc.org/~nexus/chachoua.html.
- To obtain the video of Dr Chachoua's 1995 lecture, contact Independent Medical Research, Suite 401, 135 Macquarie Street, Sydney NSW 2000, Australia, phone +61 (0)2 9247 5366, fax +61 (0)2 9247 5453. Price: AUD\$35 + \$6 p&h in Aust, \$8 to NZ, \$15 to UK/Europe (PAL); AUD\$45 + \$15 p&h to USA (NTSC).
- Dr Chachoua's book, *The Challenge, The Promise & The Cure*, is scheduled to be published in late 1998.